



NEW ITEMS 2017

LOCOMOTIVES, WAGONS AND ACCESSORIES IN GAUGE O, HO AND N

BRAWA
A PASSION FOR DETAIL

Zaratren



O

HO

N





279 PERFECT REASONS FOR A LOT OF JOYFUL ANTICIPATION

The hearts of model railway enthusiasts are now beating faster again: In 2017, BRAWA will launch a variety of new models of gauge 0, H0 and N that convince through finest details and highest trueness to the original. The more than 200 new products of gauge H0 include many new model releases such as the E44 electric locomotive that is offered in five different variants of the Deutsche Reichsbahn (DRG), the Deutsche Bahn (DB), and the East-German Deutsche Reichsbahn (DR). The BRAWA model of this classic railway product has been designed in conformity to the original with numerous details such as a functioning pantograph-type power collector, prototypical roof equipment, and finely detailed undercarriages.

For all N-gauge friends, there are more than 60 new locomotives and wagons/coaches, including five new variants of the BR 216 diesel locomotive which is now also available with sound conforming to the original. And in gauge 0, BRAWA offers two different versions of the Xr-type work wagons as well as two medium containers for the individual equipping of container-carrying wagons.

To coincide with the Nuremberg Toy Fair, BRAWA will again release exclusive special models in a limited edition; these are introduced on the pages 94/95. These models with era-conforming advertising labels can be ordered by BRAWA specialist dealers only during the 2017 Toy Fair. So contact your BRAWA specialist dealer as quickly as possible to secure your own model already now.

We hope you have fun discovering your personally desired models!

Günter Braun
Managing Director

Katrin Braun
Managing Director



02 GAUGE 0

- 02 Freight Cars
- 03 Accessories



04 GAUGE H0

- 04 Steam Locomotives
- 06 Electric Locomotives
- 16 Diesel Locomotives
- 26 Railcars
- 31 Passenger Coaches
- 42 Freight Cars
- 74 Weathered Models
- 75 Accessories



76 GAUGE N

- 76 Diesel Locomotives
- 79 Railcars
- 82 Freight Cars

94 EXCLUSIVE MODELS



PREPARED FOR NEW TASKS. READY FOR THE USE ON YOUR INSTALLATION

MAINTENANCE CAR XR 35 DB



REPLICA OF THE ORIGINAL: W. IJLENSEER



Maintenance Car Xr 35 DB, without freight Road no. 462 671



Work wagons have always been indispensable for the railway company. They were used, for example, on every working site, howsoever small, to transport construction materials such as crushed stone or tools. However, as no money could be earned with these so-called X-wagons by the transport of goods for third parties, the intent from the beginning was to find cheap solutions for the procurement of work wagons. A solution that offered itself for this purpose was to refurbish wagons of older types by modification and to adapt them to the new requirements. Due to the continuously changing demand and

the decommissioning of worn wagons, the number of the X-wagons strongly fluctuated time and again between around 48,500 (1920), 25,000 (1930), 41,500 (1943) and 15,000 (1953).

The Xr-35 type selected by BRAWA is based on Gms-30 type wagons that lost their wagon bodies in the early 50s, or already before due to damage suffered during the war. The remaining undercarriages were equipped with new, stable side panels, thus adapting the wagons to the changed task areas.

DELIVERY DATE: 3RD QUARTER 2018

Order no. **37300**



- Axle brake frame with brake blocks in wheel plane
- Extra mounted steps, exterior handles, brake system and axle brake rod
- Engraved and separately mounted toe bearing
- Spring buffers

- Separately mounted and perforated coach body supports
- Coupling compatible to Lenz®
- Short-coupling kinematics
- Metal wheels, with inside contours

- Metal frame
- Metal exterior handles
- Originally reproduced, three-dimensional frame body



* Place your pre-order until May 31st 2017 at your specialist dealer!
The model will only be produced, if a certain amount of pre-orders will be reached.

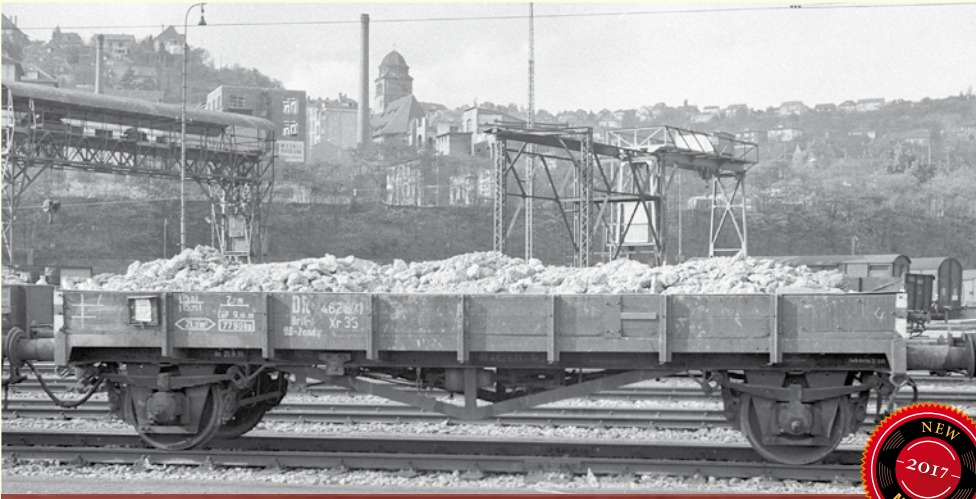

Order no. **37301**

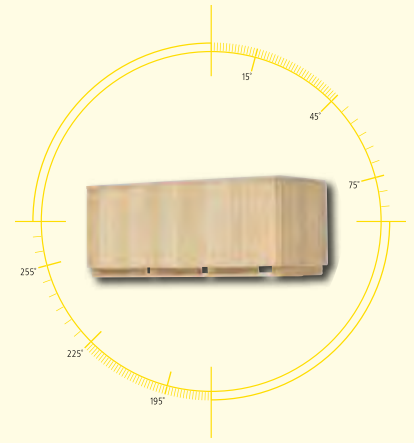

Maintenance Car Xr 35 DB,
with wooden box as freight
Road no. 464 417

DELIVERY DATE: 3RD QUARTER 2018

Wooden Box

- For loading of BRAWA H0 Freight Cars, e. g. Maintenance Car Xr, etc.



Printing Wooden Box: DB
Further information see
www.brawa.de

Order no. **93712**

DELIVERY DATE: 2ND QUARTER 2017

Closed Medium Container Type Ekrt, individual
suitable for Container Cars BTs 30



Order no. **93708**



DELIVERY DATE: 2ND QUARTER 2017

Open Medium Container Type Eoskrt 021, individual
suitable for Container Cars BTs 30



Order no. **93709**



DELIVERY DATE: 2ND QUARTER 2017





Steam Locomotive BR G10 K.P.E.V.
Road no. 5490 Königsberg

The company Henschel took on the engineering of the locomotive designated the G 10. They used the proven boiler of the P 8 and drive wheels with a diameter of 1,400 mm – a dimension that was to become the standard up to the end of the construction of steam locomotives for goods trains. In 1910, Henschel supplied the first 49 engines, which went into service at KED (royal railway directorate) Breslau, Cöln, Frankfurt, Königsberg, Mainz and Saarbrücken. The 5101 Saarbrücken went on show at the Brussels World Exhibition, and the later 5428 Saarbrücken represented German locomotive production in Buenos Aires. Up to 1915, as many as 548 Prussian G 10 were built. Due to the war, none were supplied in 1916. They were used in all Prussian directorates for goods and passenger trains. Most of the engines belonged to the rolling stock of the railway depots in the Rhine and Ruhr region.

DELIVERY DATE: 3RD QUARTER 2017



Order no. 40840	Analog BASIC+	20		Order no. 40842	Digital EXTRA		
Order no. 40841	Digital BASIC+	20		Order no. 40843	Digital EXTRA		

Model: Boiler, chassis, tender and body in die-cast zinc; finest metal spoked wheels; smoke generator and sound decoder, either built in or as a retrofit option; true-to-epoch lighting, multipart lamp housing; illuminated driver's cab; standard shaft front and rear with link guide; close coupling between locomotive and tender; perfectly replicated back boilerplate; metal, filigree reversing gear; finest paintwork and printing; lines and extra mounted parts in minimum material thickness; drive in the locomotive; empty coal chute, coal insert enclosed; single axle bearing





Order no. 40856	Analog BASIC+	20		Order no. 40858	Digital EXTRA		
Order no. 40857	Digital BASIC+	20		Order no. 40859	Digital EXTRA		
III	METAL	217,4	Rmin 360	PluX 22	2)		



Order no. 40844	Analog BASIC+	20		Order no. 40846	Digital EXTRA		
Order no. 40845	Digital BASIC+	20		Order no. 40847	Digital EXTRA		
III	METAL	217,4	Rmin 360	PluX 22	2)		DB



Order no. 40852	Analog BASIC+	20		Order no. 40854	Digital EXTRA		
Order no. 40853	Digital BASIC+	20		Order no. 40855	Digital EXTRA		
III	METAL	217,4	Rmin 360	PluX 22	2)		NSB

Steam Locomotive BR 57.10 DRG

Road no. 57 1673

Originally, the series designation was intended to be 33, however the G 10 finally received the designation BR 57.10-35. In total, there were 2,358 engines with this designation. Just like in Prussian times, these engines were used especially on routes with a weaker superstructure but heavy goods traffic. Included here were Rbd (imperial railway directorate) Essen, Wuppertal, Breslau, Erfurt, Hannover and Kassel. The G 10 also quickly became established in the Bavarian directorates, with Augsburg, München, Nuremberg, Regensburg, Würzburg and Ludwigshafen together accounting for 156 G 10s by 1924.

DELIVERY DATE: 3RD QUARTER 2017

Steam Locomotive BR 57.10 DB

Road no. 57 1390

DELIVERY DATE: 3RD QUARTER 2017

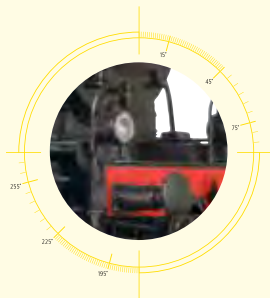

Steam Locomotive BR 61 a NSB

Road no. 57 3431

DELIVERY DATE: 3RD QUARTER 2017



NEU
NEW
NOW WITH BRAWA-SOUND



Steam Locomotive BR 422 CSD

Road no. 422.0115

After the end of World War I in 1918, 105 locomotives of the 178 series of the Imperial-Royal [Austrian] State Railways (kkStB) remained in the fleet of the newly founded Czechoslovakian State Railway CSD. At the CSD, the locos were placed in the group designated 442.0. The last locos were sidetracked in 1970, but several machines survived.

DELIVERY DATE: 3RD QUARTER 2017

Order no. 40792	Analog BASIC+	20		Order no. 40794	Digital EXTRA		
III	METAL	106,9	Rmin 360			ČSD	

Model: Metal chassis, boiler, wheels and water tanks; extra mounted metal handrails; true-to epoch lighting, multipart lamp housing; finest paintwork and printing; filigree reversing gear; smoke generator and sound decoder, either built in or as a retrofit option

NEU
NEW
NOW WITH BRAWA-SOUND



Electric Locomotive BR 211 DR

Road no. 211 071-6

The "Holzroller", as the electric locomotives of Class E11/E42 were also nicknamed, were supplied to the Deutsche Reichsbahn by VEB Lokomotivbau-Elektrotechnische Werke "Hans Beimler" in Henningsdorf from 1961 onwards. After 1970 the locomotives were then re-designated according to the valid regulations as Class 211/242 and for a long time they were the backbone of electric train transport at the DR.

DELIVERY DATE: 3RD QUARTER 2017

Order no. 43106	Analog BASIC+		Order no. 43108	Digital EXTRA		
IV	106,9	Rmin 360	PluX 22	2		DR

Model: Additional mirror; finest paintwork and printing; true-to-scale fan-grill; extra mounted steps and handrails in low material thickness; extra mounted windscreen wiper; true-to-original pantograph

Electric Locomotive BR E95 DRB

Road no. E95 01

The Deutsche Reichsbahn Gesellschaft was dissolved in 1937 in accordance with the law and the Deutsche Reichsbahn was directly assigned as special assets to the Transport Minister as member of the German Government. The new legal structure also became evident on the outside of the locomotives, which were given a new identity of ownership, a combination of the imperial eagle and the party symbol. The 6 locomotives in the E95 series were also gradually adorned with this new identity. All locomotives in the E95 series were stationed at this time at the Hirschberg depot in Silesia.

DELIVERY DATE: 2ND QUARTER 2017



Order no. 43158	Analog BASIC+		Order no. 43160	Digital EXTRA		
Order no. 43159	Digital BASIC+		Order no. 43161	Digital EXTRA		

II	240,3	Rmin 360	PluX 22	4		
----	-------	-------------	------------	---	--	--

Model: Detailed three-dimensional chassis; finest paintwork and printing; free-standing handrails, pantographs, roof lines and lamps; true-to-original pantograph; in-plane assembled windows; true-to-original roof fittings; two motors; 3rd front light can be programmed on the main, in digital mode with a function key



**NEU
NEW**
NOW WITH BRAWA-SOUND



Steam Locomotive BR 178 BBÖ
Road no. 178.802

After the First World War, the stock of locomotives of the 178 class had been seriously depleted. There were only 66 machines that could be taken over by the BBÖ. Through rebuilding and the acquisition of locomotives built for private railways, they increased the stock slightly to 85 units. In 1938, DRG classified 84 of them as 92 2211 – 92 2294. The ÖBB had 50 locomotives in 1945. They were deployed for shunt service and for the operation of ports. Most of them were discharged and disassembled between 1958 and 1968. 4 of these little machines still remain in Austria today.
DELIVERY DATE: 3RD QUARTER 2017

Order no. 40796	Analog BASIC+	20	Order no. 40798	Digital EXTRA	20	BB Österreich
NEU	METAL	106,9	Rmin 360	PluX 22	2)	DR

Model: Metal chassis, boiler, wheels and water tanks; extra mounted metal handrails; true-to epoch lighting, multipart lamp housing; finest paintwork and printing; filigree reversing gear; smoke generator and sound decoder, either built in or as a retrofit option

**NEU
NEW**
NOW WITH BRAWA-SOUND



Electric Locomotive BR 211 DR
Road no. 211 049-2

DELIVERY DATE: 3RD QUARTER 2017

Order no. 43110	Analog BASIC+	Order no. 43112	Digital EXTRA	DR
IV	106,9	Rmin 360	PluX 22	2)

Model: Additional mirror; finest paintwork and printing; true-to-scale fan-grill; extra mounted steps and handrails in low material thickness; extra mounted windscreen wiper; true-to-original pantograph

Electric Locomotive BR E95 DRG
Road no. E95 06

In the mid-nineteen twenties, the Deutsche Reichsbahn required a fast and powerful electric locomotive for transporting coal to Berlin. It was planned to use this locomotive for freight trains with loads of up to 2,200 tonnes and to pull passenger trains at a speed of 65 km/h. The necessary tractive power meant that the locomotive needed at least six driven axles, and in order to attain the planned speeds at the state of the art, additional guiding axles were necessary. The first of a total of six locomotives were delivered by AEG in late 1927. The rest had been delivered by mid-1928. The locomotives consisted of double locomotive units, each half being practically identical. The locomotives delivered 2,418 kW of power. Their length of 20.9 m and service mass of 138.5 tonnes make them the largest and heaviest German electric locomotives ever built.
DELIVERY DATE: 2ND QUARTER 2017



Order no. 43162	Analog BASIC+	Order no. 43164	Digital EXTRA	DR
Order no. 43163	Digital BASIC+	Order no. 43165	Digital EXTRA	DR
II	240,3	Rmin 360	PluX 22	4)

Model: Detailed three-dimensional chassis; finest paintwork and printing; free-standing handrails, pantographs, roof lines and lamps; true-to-original pantograph; in-plane assembled windows; true-to-original roof fittings; two motors; 3rd front light can be programmed on the main, in digital mode with a function key





MILESTONE IN ELECTRIC LOCOMOTIVE DEVELOPMENT WITH PULSATING DETAILS

ELECTRIC LOCOMOTIVE E44 DRG

At the end of the 1920s, it became clear that Deutsche Reichsbahn Gesellschaft (DRG) would have to acquire new electric locomotives, among other things, to accelerate its goods traffic. The need to increase maximum speeds to at least 80 km/h could not be met with the most recently purchased E77 and E75 series since the standard drive technology by means of bars and additional trailing wheelsets did not allow for higher speeds. The good experiences from abroad and with the two Bavarian EG 1 with the Bo'Bo' two-bogie locomotives convinced the DRG to deviate from single-frame construction as well. The arrival of the world economic crisis in 1929, however, put a halt to this plan by interrupting the cost-intensive electrical expansion of the lines, thus eliminating the need for electric locomotives. The locomotive industry in Germany, however, feared falling behind current developments due to this pause in procurement. They therefore began developing a cheaper design at their own costs. Thus a prototype with the designation E44 70 was created at the Siemens-Schuckert Works (SSW) under the general management of Walter Reichel. This prototype later became the E44 001. SSW was able to integrate its experience with electric arc

welding from its production of components for electric generators into locomotive manufacturing, which led to significant savings in materials and manufacturing costs. The prototype's positive test results convinced DRG to further develop the new locomotive type into a universal locomotive. The result was Germany's first two-bogie electric locomotive produced in series, which can safely be categorised as the prototype for the subsequently developed standard electric locomotive of Deutsche Bundesbahn (DB). Due to the war the delivery of the locomotives, which were registered for 90 km/h, stretched from 1933 into the postwar period, and Henschel only handed over the last one, a E44 187G, to DB on 29 November 1954. The predominant distribution to central and southern Germany led to the fact that approximately 100 locomotives remained in West Germany and around 50 in East Germany after the war. The most conspicuous design changes at DB were the lengthening of the roof shield for accident prevention and the Indusi (inductive train control system) equipment. The last locomotives, however, remained in service until 1985. Of the original 187 locomotives, only 21 still exist today, partially as museum locomotives and as spare parts donors.



REPLICA OF THE ORIGINAL: U. BUDDÉ



Electric Locomotive BR E44 DRG

Road no. E44 007



LAYOUT VERSION



Order no. 43400	Analog BASIC+		Order no. 43402	Digital EXTRA	Energy Storage	DASH
Order no. 43401	Digital BASIC+		Order no. 43403	Digital EXTRA	Energy Storage	DASH

NEM	175,7	Rmin 360	PluX 22	2)								
-----	-------	-------------	------------	-----	--	--	--	--	--	--	--	--

Model: Pantograph type SBS 10; main switch type R 618; with 16 sand boxes; in analog mode the 3rd front light can be switched on or off with a switch, in digital mode with a function key

DELIVERY DATE: 1ST QUARTER 2018



Details:

- Extra mounted handrails in low-material thickness
- Three-point support
- True-to-epoch lightning
- Finely detailed chassis
- Finest paintwork and printing
- Free standing roof lines
- Illuminated driver's cab
- Functioning metal pantographs (mechanical)
- Prepared for sound or with built-in sound
- LED lighting
- NEM-standard close-coupling
- Illuminated machine room
- Metal wheels and frame
- Prototypical multipart roof-fittings
- Many extra mounted parts
- Reproduction of the different pantograph and main switch types

Digital Version EXTRA:

- Incl. Energy storage (buffers sound, motor and light)
- Extensive light functions: shunting lights, drivers cabin lighting, tail lights separately switchable
- Optimized lighting control for drive and shunting mode
- Flicker-free light, due to stabilized and through a separate capacitor buffered 5 V power supply
- True-to-original sound
- Noiseless 16-bit Sound with up to 8 independent channels thanks to newest sound technology and excellent sound characteristics
- Optimal motor and load control for perfect running characteristics
- Applicable in all established digital systems (DCC, Motorola, SX1 und SX2)
- Enclosed Locomotive card in the AC-Version

For more details on the technical functions of the various engine types, see the overview on page 11.

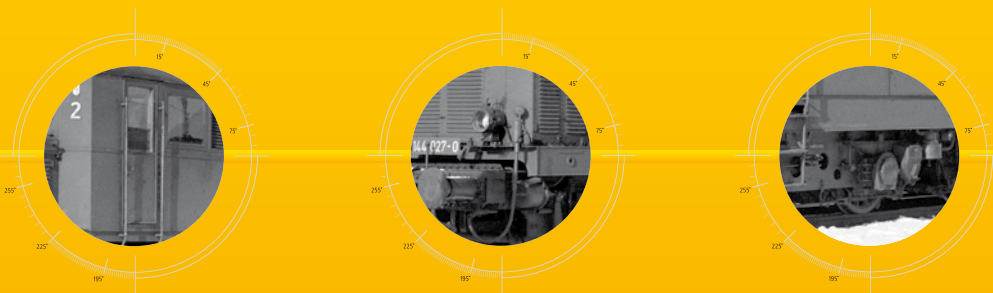



LAYOUT VERSION



Order no. 43404	Analog BASIC		Order no. 43406	Digital EXTRA		Energy Storage		
---------------------------	-----------------	--	---------------------------	------------------	--	-------------------	--	--

Order no. 43405	Digital BASIC+		Order no. 43407	Digital EXTRA		Energy Storage		
---------------------------	-------------------	--	---------------------------	------------------	--	-------------------	--	--

	175,7	Rmin 360	PluX 22	2)				
--	-------	-------------	------------	-----	--	--	--	--

Model: Pantograph type SBS 10; main switch type R 618; with 8 sand boxes, indusi and extended roof

Electric Locomotive BR E44 DB
Road no. E44 100

DELIVERY DATE: 1ST QUARTER 2018

Electric Locomotive BR E44^w DB
Road no. E44 181^w

After the annexation of Austria, the E44 locomotives were supposed to be used also on the alpine routes of the "Ostmark". In order to minimize the brake block wear during downhill ride, the installation of an electric dynamic brake was required. The German National Railway (DRB) ordered such an additional device for the machines of the batch E44 152 – 191 and referred to the subtype as E44^w for "Widerstandsbremse" (dynamic brake). Because of the war, only the models E44^w 152 – 183 were delivered between 1943 and 1951. Externally, the machines attracted attention primarily by the roof-mounted vent stacks of the dynamic brakes. After 1945, the German Railway (DB) maintained the dynamic brake only for the 16 Freiburg-based locomotives, which were used on the Höllental railway track, and referred to these as E44.11 from 1962 onwards, and as BR 145 after 1968. On all other machines, the electric brake was removed or, in case of a damage, decommissioned. The machines E44 1170 and 1180 survived; we can only hope that one of them will once again "hum" past the Hirschprung (location where a stag is said to have leapt over the Höllental).

DELIVERY DATE: 1ST QUARTER 2018

LAYOUT VERSION



Order no. 43408	Analog BASIC		Order no. 43410	Digital EXTRA		Energy Storage		
---------------------------	-----------------	--	---------------------------	------------------	--	-------------------	--	--

Order no. 43409	Digital BASIC+		Order no. 43411	Digital EXTRA		Energy Storage		
---------------------------	-------------------	--	---------------------------	------------------	--	-------------------	--	--

	175,7	Rmin 360	PluX 22	2)				
--	-------	-------------	------------	-----	--	--	--	--

Model: Pantograph type SBS 39; main switch type R 628; with 8 sand boxes, indusi and extended roof; with dynamic brake for the first time in a model (deviating photo)

Electric Locomotive BR 144 DB
Road no. 144 119-5

DELIVERY DATE: 1ST QUARTER 2018

LAYOUT VERSION



Order no. 43412	Analog BASIC		Order no. 43414	Digital EXTRA		Energy Storage		
---------------------------	-----------------	--	---------------------------	------------------	--	-------------------	--	--

Order no. 43413	Digital BASIC+		Order no. 43415	Digital EXTRA		Energy Storage		
---------------------------	-------------------	--	---------------------------	------------------	--	-------------------	--	--

	175,7	Rmin 360	PluX 22	2)				
--	-------	-------------	------------	-----	--	--	--	--

Model: Pantograph type SBS 39; main switch type R 628; with 8 sand boxes, indusi and extended roof; design with small DB-reflective glazing-laterns



OVERVIEW OF ORDER NUMBERS AND TECHNICAL FUNCTIONS BR E44

		BASIC+		EXTRA	
	Ep.	Analog BASIC+ =	Digital BASIC+ ~	Digital EXTRA =	Digital EXTRA ~
Electric Locomotive BR E44 DRG	II	Order-no. 43400	Order-no. 43401	Order-no. 43402	Order-no. 43403
Electric Locomotive BR E44 DB	III	Order-no. 43404	Order-no. 43405	Order-no. 43406	Order-no. 43407
Electric Locomotive BR E44 ^W DB	III	Order-no. 43408	Order-no. 43409	Order-no. 43410	Order-no. 43411
Electric Locomotive BR 144 DB	IV	Order-no. 43412	Order-no. 43413	Order-no. 43414	Order-no. 43415
Electric Locomotive BR 244 DR	IV	Order-no. 43416	Order-no. 43417	Order-no. 43418	Order-no. 43419

Technical functions	Analog BASIC+ =	Digital BASIC+ ~	Digital EXTRA =	Digital EXTRA ~
Driving function	+	+	+	+
Light change	+ ¹⁾	+	+	+
Tail lights separately switchable	+ ¹⁾	+ ²⁾	+	+
Driver cabin lighting	+ ¹⁾	+ ²⁾	+	+
Long-distance headlights			+	+
Shunting lights			+	+
Light setting programmable for analogue operation			+	+
Digital interface	PluX22	PluX22	PluX22	PluX22
Decoder		+	+	+
Sound			+	+
Energy Storage			+	+
Additional information	<ul style="list-style-type: none"> Optimised light control for driving and shunting modes Subsequent conversion from analog to digital via PluX22 interface possible 		<ul style="list-style-type: none"> Optimised light control for driving and shunting modes Compatible with and programmable in all common digital systems (DCC, Motorola, SX1 and SX2) 	

¹⁾ In analog mode function over switch selectable and in digital mode over function button
²⁾ Function only available in digital mode



- Extra mounted handrails in low-material thickness
- Three-point support
- True-to-epoch lightning
- Finely detailed chassis
- Finest paintwork and printing
- Free standing roof lines

- Illuminated driver's cab
- Functioning metal pantographs (mechanical)
- Prepared for sound or with built-in sound
- LED lighting
- NEM-standard close-coupling
- Illuminated machine room

- Metal wheels
- Prototypical multipart roof-fittings
- Many extra mounted parts
- Reproduction of the different pantograph and main switch types

LAYOUT VERSION



Order no. 43416	Analog BASIC+	PluX22	Order no. 43418	Digital EXTRA	Energy Storage	PluX22
Order no. 43417	Digital BASIC+	PluX22	Order no. 43419	Digital EXTRA	Energy Storage	PluX22



Model: Pantograph type RBS 58; main switch type DAT1; with 8 sand boxes

Electric Locomotive BR 244 DR
Road no. 244 069-1

DELIVERY DATE: 1ST QUARTER 2018



Electric Locomotive BR E75 DRG
Road no. E75 62

In 1926, DRG ordered further electric locomotives as improvements on the E77 for operation in the southern and central German network. While the electrical systems remained virtually unchanged, a new one part vehicle frame was designed with the axle sequence 1'BB1'. Due to the running gear changes, the maximum permissible speed was set at 70 km/h, raising hopes of better utility in mixed passenger and goods train schedules. 79 locomotives were planned. E75 01-12 went to south Germany, while the E75 51-69 went to Leipzig West, Wahren, Bitterfeld and Magdeburg-Buckau.

DELIVERY DATE: 3RD QUARTER 2017



Order no. 43228	Analog BASIC+	Order no. 43230	Digital EXTRA
Order no. 43229	Digital BASIC+	Order no. 43231	Digital EXTRA

Model: 3rd front light can be switched on or off with a switch, in digital mode with a function key

OVERVIEW OF ORDER NUMBERS AND TECHNICAL FUNCTIONS E75

		BASIC+		EXTRA	
	Ep.	Analog BASIC+ =	Digital BASIC+ ~	Digital EXTRA =	Digital EXTRA ~
Electric Locomotive BR E75 DB	III	Order-no. 43216	Order-no. 43217	Order-no. 43218	Order-no. 43219
Electric Locomotive BR 175 DB	IV	Order-no. 43220	Order-no. 43221	Order-no. 43222	Order-no. 43223
Electric Locomotive BR E75 DRG	II	Order-no. 43228	Order-no. 43229	Order-no. 43230	Order-no. 43231
Electric Locomotive BR E75 DB	III	Order-no. 43232	Order-no. 43233	Order-no. 43234	Order-no. 43235
Technical functions		Analog BASIC+ =	Digital BASIC+ ~	Digital EXTRA =	Digital EXTRA ~
Driving function		+	+	+	+
Light change		+ ¹⁾	+	+	+
Tail lights separately switchable		+ ¹⁾	+ ²⁾	+	+
Driver cabin lighting		+ ¹⁾	+ ²⁾	+	+
Long-distance headlights				+	+
Shunting lights				+	+
Light setting programmable for analogue operation				+	+
Digital interface		PluX22	PluX22	PluX22	PluX22
Decoder			+	+	+
Sound				+	+
Additional information		<ul style="list-style-type: none"> Subsequent conversion from analog to digital via PluX22 interface possible 	<ul style="list-style-type: none"> Compatible with and programmable in all common digital systems (DCC, Motorola, SX1 and SX2) 	<ul style="list-style-type: none"> Optimised light control for driving and shunting modes Latest sound technology and excellent sound quality Compatible with and programmable in all common digital systems (DCC, Motorola, SX1 and SX2) Improved motor and load control 	

¹⁾ In analog mode function over switch selectable and in digital mode over function button
²⁾ Function only available in digital mode



- Extra mounted handrails in low-material thickness
- Three-point support
- Finely detailed chassis
- Finest paintwork and printing
- Functioning pantographs (mechanical)
- Reproduction of machine room
- LED lighting
- Metal arrangement of rods

- Metal wheels and frame
- True-to-original: different front windows and lanterns
- Prototypical multipart roof-fittings
- High maintainability due to simple dismantling of the body
- Re-lubrication of the engine bearings and screws is possible through holes in the PC board and gearbox cover or after dismantling of the body





Electric Locomotive BR E75 DB
Road no. E75 55

AW Freimann performed a general overhaul of the locomotives E75 09, E75 55 and E75 69 between 1960 and 1961. Apart from ly invisible changes such as hard manganese plates on the axle guides or new wiring, the front ends of the locomotives were visibly modified. The window screens were replaced by new, rubber-mounted windscreens. DELIVERY DATE: 3RD QUARTER 2017

Order no. 43232	Analog BASIC+		Order no. 43234	Digital EXTRA		
Order no. 43233	Digital BASIC+		Order no. 43235	Digital EXTRA		

176,8

Model: With new front



Electric Locomotive BR E75 DB
Road no. E75 66

DELIVERY DATE: 3RD QUARTER 2017

Order no. 43216	Analog BASIC+		Order no. 43218	Digital EXTRA		
Order no. 43217	Digital BASIC+		Order no. 43219	Digital EXTRA		

176,8



Electric Locomotive BR 175 DB
Road no. 175 054-6

The Deutsche Bundesbahn ran the E75 mostly in the region of BD Munich. Freilassing, Ingolstadt, München, Rosenheim and Treuchtlingen were now the new homes of all the remaining E75s. Of the 22 locomotives still around in 1950, the last were taken out of service in 1972. DELIVERY DATE: 3RD QUARTER 2017

Order no. 43220	Analog BASIC+		Order no. 43222	Digital EXTRA		
Order no. 43221	Digital BASIC+		Order no. 43223	Digital EXTRA		

176,8



**TRAXX Electric Locomotive Re1428
Green Cargo**

Road no. 91 74 000 1428-3

New, stricter safety specifications forced Bombardier to increase the crash safety of the TRAXX 1 locomotive body. As a result, the TRAXX 2 locomotives that have been manufactured since 2005 boast a vertical front section at the bottom as well as altered shunting treads on the fronts. Many components inside the vehicle were also simplified and standardised in order to be able to respond to customer desires in a more flexible manner whilst also reducing in-house production work. For instance, the time for the final assembly of a TRAXX locomotive has been reduced to a maximum of two weeks. In order to also be able to distinguish them in terms of their fleet number, the locomotives have been issued with the subclass numbers 185.2 and 146.2 to 146.5 at Deutsche Bahn AG. In the meantime, Bombardier has globally produced over 1500 units of this highly successful TRAXX family.

DELIVERY DATE: 3RD QUARTER 2017



Order no. 43964	Analog BASIC	Order no. 43966	Analog BASIC+	Order no. 43968	Digital EXTRA
		Order no. 43967	Digital BASIC+	Order no. 43969	Digital EXTRA

VI 217,2 Rmin 360 PluX 22 2) [Icons] green cargo [Flag: Sweden]

Model: Attached grip rails (head end); illuminated train destination display; top-quality printing and painting; driver's cab lighting; prepared for sound, or with sound installed; etched treadplates; incl. snowplough; LED lighting; windscreen wipers attached individually; traction tyres; different design of the train compartments; PluX22 interface; driver's cab lighting switchable like the original; long-distance headlights raise like the original; smooth, steady setting off even in speed level 1; setting off and braking delay like the original; optimal power consumption; chassis with free view and details true to the original; simple, cable-free dismantling of the housing possible as well as non-twist locking lugs; roof sections true to the different versions with 2 or 4 pantographs; true-to-original rest position of the pantographs; metal frame



Order no. 43988	Analog BASIC	Order no. 43990	Analog BASIC+	Order no. 43992	Digital EXTRA
		Order no. 43991	Digital BASIC+	Order no. 43993	Digital EXTRA

VI 217,2 Rmin 360 PluX 22 2) [Icons] CargoNet [Flag: Norway]

**TRAXX Electric Locomotive CE 119
CargoNet**

Road no. 91 76 0119 002-3

DELIVERY DATE: 3RD QUARTER 2017



Order no. 43994	Analog BASIC	Order no. 43996	Analog BASIC+	Order no. 43998	Digital EXTRA
		Order no. 43997	Digital BASIC+	Order no. 43999	Digital EXTRA

VI 217,2 Rmin 360 PluX 22 2) [Icons] bls cargo [Flag: Switzerland]

**TRAXX Electric Locomotive BR 186
"Alpinist" BLS**

Road no. 91 85 4486 504-4

DELIVERY DATE: 3RD QUARTER 2017





Order no. 43800	Analog BASIC	Order no. 43802	Analog BASIC+	Order no. 43804	Digital EXTRA	Digital EXTRA	Digital EXTRA
		Order no. 43803	Digital BASIC+	Order no. 43805	Digital EXTRA	Digital EXTRA	Digital EXTRA

**TRAXX Electric Locomotive
BR 186 CROSSRAIL**
Road no. 91 80 6186 150-9

DELIVERY DATE: 3RD QUARTER 2017

OVERVIEW OF ORDER NUMBERS AND TECHNICAL FUNCTIONS TRAXX

Order numbers	Ep.	BASIC	BASIC+	EXTRA		
		Analog Basic =	Analog BASIC+ =	Digital BASIC+ ~	Digital EXTRA =	Digital EXTRA ~
TRAXX Electric Loc. BR 186 CROSSRAIL	VI	Order-no. 43800	Order-no. 43802	Order-no. 43803	Order-no. 43804	Order-no. 43805
TRAXX Electric Loc. Re1428 Green Cargo	VI	Order-no. 43964	Order-no. 43966	Order-no. 43967	Order-no. 43968	Order-no. 43969
TRAXX Electric Loc. CE 119 CargoNet	VI	Order-no. 43988	Order-no. 43990	Order-no. 43991	Order-no. 43992	Order-no. 43993
TRAXX Electric Loc. BR 186 "Alpinist" BLS	VI	Order-no. 43994	Order-no. 43996	Order-no. 43997	Order-no. 43998	Order-no. 43999

Technical functions	Analog Basic =	Analog BASIC+ =	Digital BASIC+ ~	Digital EXTRA =	Digital EXTRA ~
	Driving function	+	+	+	+
Light change	+	+	+	+	+
Tail lights separately switchable		+ ¹⁾	+ ¹⁾	+	+
Driver cabin lighting		+ ¹⁾	+ ¹⁾	+	+
Shunting lights		+ ¹⁾	+ ¹⁾	+	+
Long-distance headlights		+ ¹⁾	+ ¹⁾	+	+
Destination indicator (model dependently)	+	+	+	+	+
Light setting programmable for analogue operation		+	+	+	+
Digital interface		PluX22	PluX22	PluX22	PluX22
Decoder			+	+	+
Sound				+	+
Additional information	Cannot be digitized	<ul style="list-style-type: none"> Optimised light control for driving and shunting modes Subsequent conversion from analog to digital via PluX22 interface possible Easy decoder installation without extensive reprogramming; all significant values for the control of the light for instance can be found on the main circuit board and do not depend on the installed decoder 	<ul style="list-style-type: none"> Optimised light control for driving and shunting modes Compatible with and programmable in all common digital systems (DCC, Motorola, SX1 and SX2) 	<ul style="list-style-type: none"> Optimised light control for driving and shunting modes Latest sound technology and excellent sound quality Compatible with and programmable in all common digital systems (DCC, Motorola, SX1 and SX2) Improved motor and load control 	

¹⁾ Function only available in digital mode

GENERAL INFORMATION ABOUT OUR DIGITAL DECODER

For all our locomotives we use digital decoders developed by BRAWA in cooperation with Doehler & Haass:

- Compatible with and programmable in all common digital systems (DCC, Motorola, SX1 and SX2)
- RailCom® compatible
- Improved motor and load control for perfect running properties
- Interference-free 16-bit sound with up to 8 independent channels thanks to the latest sound technology and excellent sound quality, e.g. signal horn with true-to-original reverberation
- Version-specific sound: diesel and electric locomotive, passenger train or goods locomotive
- Easy to program
- Optimised light control for driving and shunting modes
- Extensive light functions: raised headlights, dipped headlights, shunting lights, driver's cab lighting, country-specific light functions Germany / Switzerland (also capable of analog control!)
- Illuminated train destination display in true-to-original lettering size and colour (for passenger train models)
- Easy decoder installation without extensive reprogramming
- AC version with locomotive card included for recognition of the function symbols in Mfx operation
- The technical components are developed and manufactured exclusively in Germany.





RELIABLE TOP SELLER WITH CHARACTERISTIC DETAILS

DIESEL LOCOMOTIVE V36

One of the primary reasons behind the development of the 360 HP WR 360 C 14 diesel locomotive with fluid transmission was the demand made for the Wehrmacht railway facilities to be "smoke-free". The reason for this was to eliminate the possibility of locations such as ammunition depots or refineries to be detected from the air as a result of steam plumes generated by a steam locomotive. Thanks to a working partnership that included Berliner Maschinenfabrik AG (previously Louis Schwartzkopff), Orenstein & Koppel as well as Deutz and Voith (only for engine and transmission issues), two prototypes were created within one year which were then comprehensively tested by the German National Railway Locomotive Testing Office during the second half of 1937. The acquired knowledge was then immediately implemented into the further development so that further preliminary locomotives were manufactured as early as 1938. The first of the 245 volume production locomotives entered service at the start of 1939 and were supplied to the army, air force, navy as well as industrial companies. In doing so, the WR 360 C 14 trains were powered by Deutz or MWM engines that were also used in submarines at the time. During the Second World War, the WR 360 C 14 trains made it to many countries throughout Europe and even to North Africa, where some of them also remained. Consequently, several WR 360 C 14

were not only in use on the German Federal and National Railway after 1945; they were also running in countries such as Austria, France and Italy. Now operating under the V36 designation, the locomotives were primarily used in the shunting service and in front of transfer trains in the German Federal Railway. They were also used for suburban passenger transport in the greater Wuppertal, Frankfurt and Nuremberg areas. For this purpose, some locomotives were equipped with a simplified push-pull control or were converted to a one-man control system and equipped with a rooftop cockpit. This ensured that the locomotive staff had an improved view during journeys where the train was pushed. Further noticeable conversions to the Federal Railway locomotives included a larger and more striking cooling water expansion tank on the front end of the engine as well as adjustable radiator shutters. The last of these locomotives, then operating as the 236 range, remained in operation up until 1981. The V36 locomotives operated by the German National Railway were kept in operation for approximately 4 further years. Private railways and industrial companies continued to use some of the locomotives until the end of the 1980s and, even today, it is possible to experience several V36 locomotives in operation on various museum tracks.



REPLICA OF THE ORIGINAL: C. BELLINGRODT, SLG. J. REINHARD

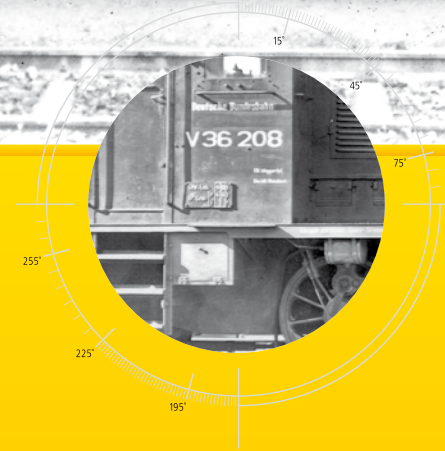
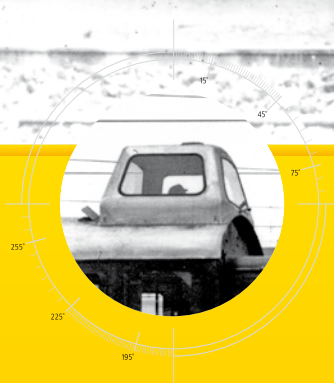
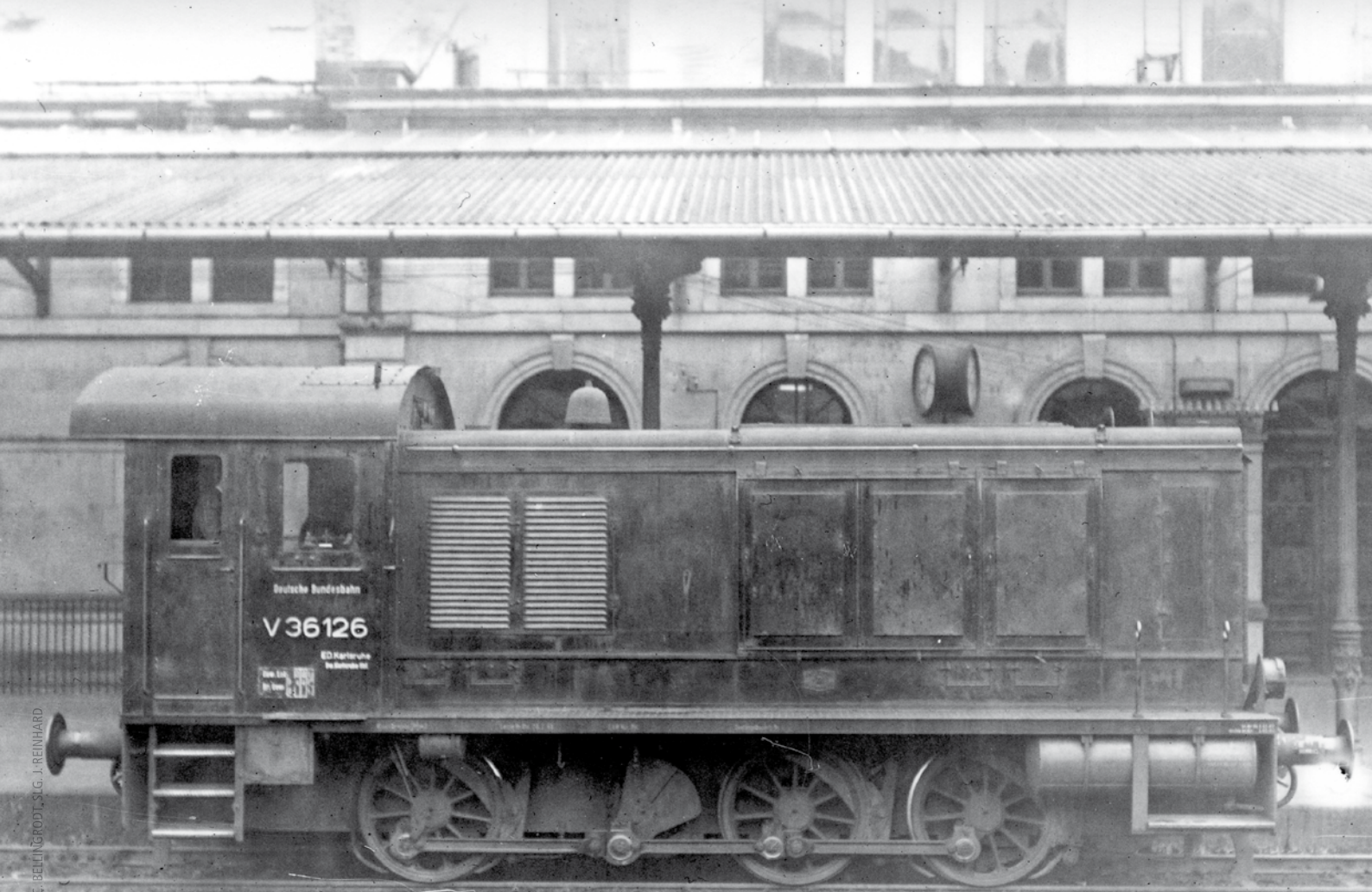

Details:

- Etched radiator grille (pototypically at models without radiator lamellas)
- Free standing handles and handrails
- Clear view through the driver cabin
- Lights equipped with maintenance-free LEDs
- Three-point support
- Finely detailed chassis
- Finest paintwork and painting
- Reproduction of the brake linkage
- Metal frame and wheels, structure made of plastic
- NEM-standard short-coupling
- Light change

Digital Version EXTRA:

- Filigree electronic coupling (interchangeable thanks to NEM-Norm)
- Incl. Energy storage (buffers sound, motor and light)
- Extensive light functions: shunting lights, drivers cabin lighting, tail lights separately switchable
- Optimized lighting control for drive and shunting mode
- Flicker-free light, due to stabilized and through a separate capacitor buffered 5 V power supply
- True-to-original sound
- Noiseless 16-bit Sound with up to 8 independent channels thanks to newest sound technology and excellent sound characteristics
- Optimal motor and load control for perfect running characteristics
- Applicable in all established digital systems (DCC, Motorola, SX1 und SX2)
- Enclosed Locomotive card in the AC-Version

Note: We use digital decoders developed by Brawa in cooperation with Doehler & Haass for models belonging to the BRAWA V36 range. The retrospective conversion to the digital version is possible via a 22-pin interface (only sound function). Please note that a later conversion of the digital remotecontrol coupling is not possible.





REPLICA OF THE ORIGINAL: C. BELLINGRODT, SLG. J. REINHARD

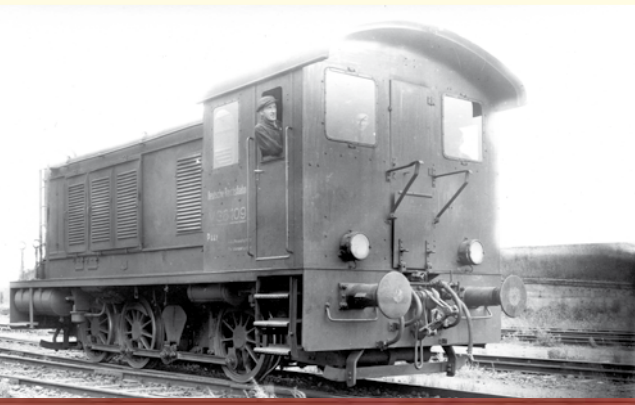

Order no. **41600**



Order no. **41602**

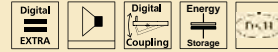

Order no. **41601**

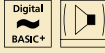

Order no. **41603**

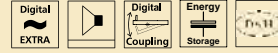

Diesel Locomotive WR 360 DRB
Road no. 36 255

DELIVERY DATE: SUMMER 2017

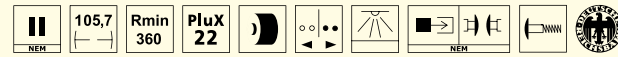

Model: Original colour replication: body grey, wheels red



REPLICA OF THE ORIGINAL: P. SCHIFFER, SLG. EISENBAHNSTIFTUNG



Order no. **41604**



Order no. **41606**

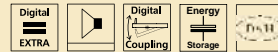

Order no. **41605**



Order no. **41607**

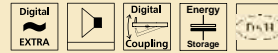

Diesel Locomotive V36 DB
Road no. V36 234

DELIVERY DATE: SUMMER 2017



REPLICA OF THE ORIGINAL: W. BÜGEL, SLG. EISENBAHNSTIFTUNG



Order no. **41608**

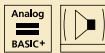

Order no. **41610**

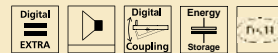

Order no. **41609**



Order no. **41611**

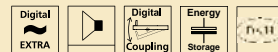

Diesel Locomotive 236 DB
Road no. 236 110-3

DELIVERY DATE: SUMMER 2017

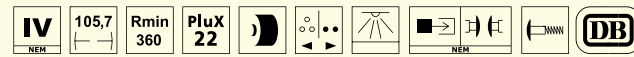

Model: True to original with rooftop cockpit



REPLICA OF THE ORIGINAL: P. SCHIFFER; S.G. EISENBAHNSTIFTUNG



Diesel Locomotive 103 DR
Road no. 103 016-2

DELIVERY DATE: SUMMER 2017

Order no.
41612



Order no.
41614

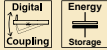

REPLICA OF THE ORIGINAL: C. BELLINGRODT, S.G. J. REINHARD



FS Italia

REPLICA OF THE ORIGINAL: MONDO FERROVIARIO



Order no. **41616**

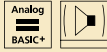

Order no. **41618**

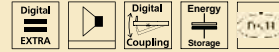

Order no. **41617**



Order no. **41619**

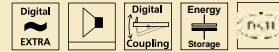

Diesel Locomotive 236 FS
Road no. 236 003

DELIVERY DATE: SUMMER 2017

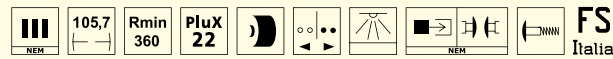

Model: Original colour replication: brown/green

DSB

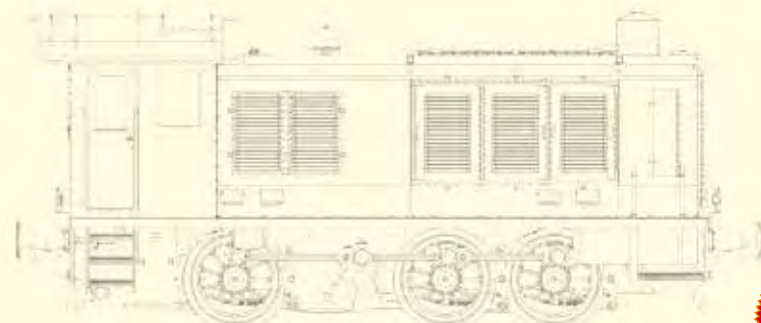

Order no. **41620**

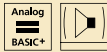

Order no. **41622**

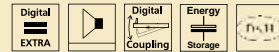

Order no. **41621**



Order no. **41623**

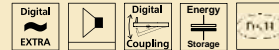

Diesel Locomotive T DSB
Road no. 1

DELIVERY DATE: SUMMER 2017

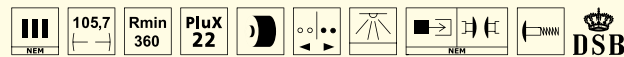

Model: Original colour replication: grey/red

SNCF

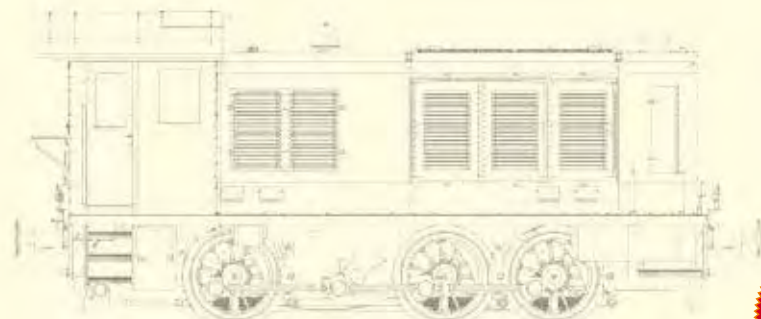

Order no. **41624**

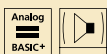

Order no. **41626**

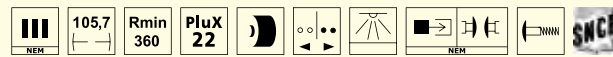
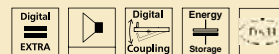

Model: Original colour replication: green/black

Diesel Locomotive 030 SNCF
Road no. 030 DB-9

DELIVERY DATE: SUMMER 2017



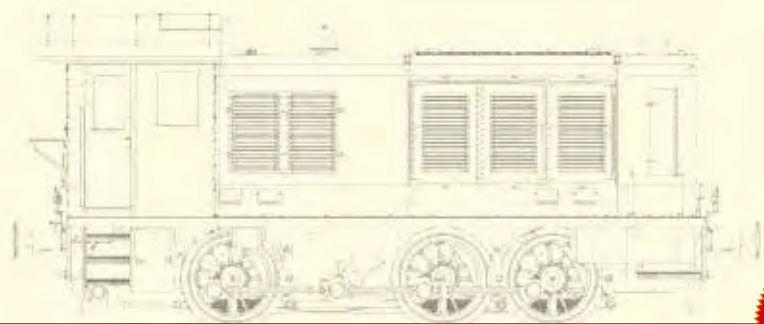

Diesel Locomotive 230 SNCB
Road no. 230.01

DELIVERY DATE: SUMMER 2017

Order no. 41628	Analog BASIC+		Order no. 41630	Digital EXTRA		Digital Coupling	Energy Storage	
Order no. 41629	Digital BASIC+		Order no. 41631	Digital EXTRA		Digital Coupling	Energy Storage	

Model: Original colour replication: green/black

REPLICA OF THE ORIGINAL: A. LUFT



Diesel Locomotive 2065 ÖBB
Road no. 2065.01

DELIVERY DATE: SUMMER 2017

Order no. 41632	Analog BASIC+		Order no. 41634	Digital EXTRA		Digital Coupling	Energy Storage	
---------------------------	------------------	--	---------------------------	------------------	--	---------------------	-------------------	--

Model: Original colour replication: green/black



REPLICA OF THE ORIGINAL: J. WAGNER

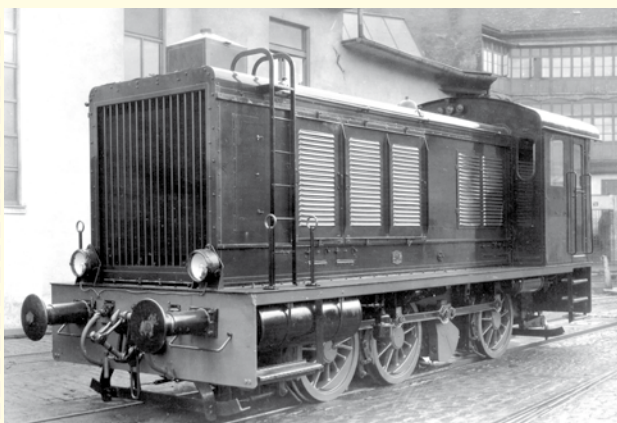

Diesel Locomotive T334 ČSD
Road no. T334.001

DELIVERY DATE: SUMMER 2017

Order no. 41638	Analog BASIC+		Order no. 41640	Digital EXTRA		Digital Coupling	Energy Storage	
---------------------------	------------------	--	---------------------------	------------------	--	---------------------	-------------------	--

Model: Original colour replication: blue/black



Diesel Locomotive V100.20 DB
Road no. V100 2007

Equipping the V100 006 with the more powerful 1,350-HP motor on a trial basis was very successful. Without really waiting for the results of further trials, the German Federal Railway (DB) ordered additional machines with the stronger motor unit. It wasn't noticed until later that the cooling system reached its capacity limits very often, whereupon, starting with V100 2020, the frame and the motor's front-end section were lengthened for a larger cooler. This is why the V100 2002-2019 differed externally from the other V100.10 only by their higher fleet number.

DELIVERY DATE: 2ND QUARTER 2017



Order no. 42868	Analog BASIC+		Order no. 42870	Digital EXTRA		Digital Coupling		Energy Storage	
Order no. 42869	Digital BASIC+		Order no. 42871	Digital EXTRA		Digital Coupling		Energy Storage	
	141,4	Rmin 360	PluX 22	2)					

Diesel Locomotive 212 DB
Road no. 212 074-9

Trials indicated that equipping the V100 with a 1,350 HP engine also permitted the locomotive to be deployed on main railway lines. In doing so, the side cooling blocks were also practically enlarged in order to increase the cooling capacity. From V100 2020 onwards, this required an extension of the engine front end by 200 mm which was compensated for by buffering the locomotive frame and resulted in a new length over buffers of 12,300 mm. In terms of design, only the length of the circumferential sheet metal needed to be adjusted. However, the biggest difference to the V100.10 is the omission of the protective grating in front of the cooler shutters that were now exposed.

AVAILABLE



Order no. 42860	Analog BASIC+		Order no. 42862	Digital EXTRA		Digital Coupling		Energy Storage	
Order no. 42861	Digital BASIC+		Order no. 42863	Digital EXTRA		Digital Coupling		Energy Storage	
	141,4	Rmin 360	PluX 22	2)					

Diesel Locomotive 213 DB
Road no. 213 340-3

During the mid-1960s, the Deutsche Bundesbahn was looking for an inexpensive replacement for the steam locomotives from the 82 and 94.5 series complete with counter-pressure brakes that were suitable for the last steep routes. In doing so, the decision was made to equip 10 locomotives from the third and final batch of the V100.20 with an additional hydrodynamic brake alongside the compressed air brake and handbrake. The most striking distinguishing feature of the V100 2332 to 2341 compared to the V100.20 series is the large air intake grille on the right hand side of the long front end directly behind the cooler shutters as well as the omission of the auxiliary diesel unit.

AVAILABLE



Order no. 42864	Analog BASIC+		Order no. 42866	Digital EXTRA		Digital Coupling		Energy Storage	
Order no. 42865	Digital BASIC+		Order no. 42867	Digital EXTRA		Digital Coupling		Energy Storage	
	141,4	Rmin 360	PluX 22	2)					





**Diesel Locomotive Serie Am847
Sersa**

Road no. Am 847 951-1

When the 211 series was decommissioned at Deutsche Bundesbahn, Sersa AG bought some of the locomotives. The Zurich company is active primarily in line construction and performs work on behalf of various railway administrators in Switzerland. Occasionally it also leases locomotives to SBB and other private companies.

DELIVERY DATE: 2ND QUARTER 2017

Order no. 42872	Analog BASIC+		Order no. 42874	Digital EXTRA		Digital Coupling		
Order no. 42873	Digital BASIC+		Order no. 42875	Digital EXTRA		Digital Coupling		



**Diesel Locomotive 211
Salzburger Lokalbahn**

Road no. V 86

DELIVERY DATE: 2ND QUARTER 2017

Order no. 42880	Analog BASIC+		Order no. 42882	Digital EXTRA		Digital Coupling		
Order no. 42881	Digital BASIC+		Order no. 42883	Digital EXTRA		Digital Coupling		



- Etched cooler grille and fan grille
- Free-standing handrails
- Spring buffers
- Clear view through the driver's cabin
- NEM-standard coupling
- Realistic reproduction of the tubular frame bogies incl. axle drive

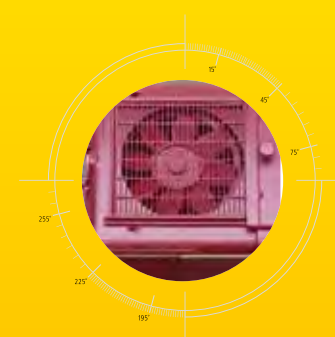

- Reproduction of brake rods
- Completely recreated driver's cab
- Zinc die-cast chassis and gear housing
- Lights fitted with maintenance-free LEDs
- All specific details of the different series taken into consideration

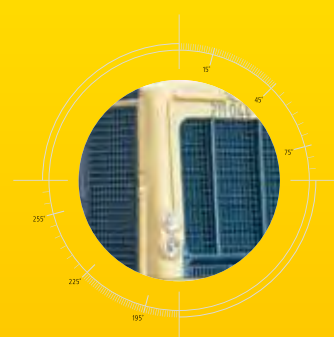

- Digital EXTRA: complete with the following features that can be digitally controlled:
Sound, automatic decoupling, driver's cabin lighting, driven fans, shunting light and red light can be individually controlled

It is possible to retrospectively convert the model from analog to digital via a 22-pin NEM interface (only sound functions). Please note that it is not possible to retrospectively convert the digital remotecontrol coupling, the driven fan or the additional light functions.



Diesel Locomotive BR V90 DB
Road no. V90 039

50 years ago, on 4th August 1964, the German Federal Railway commissioned the first of a total of 511 locomotives from the V90/290 and 291 ranges manufactured by Mak. The locomotives were developed for heavy shunting and transfer work. In order to simplify operation, a number of locomotives were equipped with radio remote control and automatic coupling which was also evident from the outside thanks to the numbers of the new 294, 295 and 296 ranges displayed on the locomotives. The locomotive family continues in reliable service to this very day: Only with the emergence of the new Voith Gravita will DB AG begin to withdraw the first BR 291/295 locomotives from the managed inventory.

DELIVERY DATE: 2ND QUARTER 2017



Order no. 41544	Analog BASIC	Order no. 41546	Analog BASIC*	Energy Storage	Order no. 41548	Digital EXTRA	Digital Coupling	Energy Storage
Order no. 41547	Digital BASIC*	Energy Storage	Order no. 41549	Digital EXTRA	Digital Coupling	Energy Storage		
III NEM	164,6	Rmin 360	PluX 22	2)				

Model: All axles are driven; all specific details of the 290, 291, 294, 295 and 296 ranges taken into account (e.g. different position of the fan, additional handrails and different bogie equipment); lights equipped with maintenance-free LEDs; chassis and gearbox housing manufactured from zinc die-casting; etched ventilator grille; spring buffers; free standing handles and handrails; clear view through the driver's cabin; light change; reproduction of the brake linkage; realistic presentation of the bogie frame incl. the axle drives

Diesel Locomotive BR 290 DB
Road no. 290 132-0

DELIVERY DATE: 2ND QUARTER 2017



Order no. 41550	Analog BASIC	Order no. 41552	Analog BASIC*	Energy Storage	Order no. 41554	Digital EXTRA	Digital Coupling	Energy Storage
Order no. 41553	Digital BASIC*	Energy Storage	Order no. 41555	Digital EXTRA	Digital Coupling	Energy Storage		
IV NEM	164,6	Rmin 360	PluX 22	2)				

Diesel Locomotive BR 291 DB
Road no. 291 020-6

DELIVERY DATE: 2ND QUARTER 2017



Order no. 41556	Analog BASIC	Order no. 41558	Analog BASIC*	Energy Storage	Order no. 41560	Digital EXTRA	Digital Coupling	Energy Storage
Order no. 41559	Digital BASIC*	Energy Storage	Order no. 41561	Digital EXTRA	Digital Coupling	Energy Storage		
IV NEM	164,6	Rmin 360	PluX 22	2)				





Diesel Locomotive V90
Detail- and function overview
as well as function keys
(PDF-document)



Diesel Locomotive BR 294 DB
Road no. 90 80 3294 154-0

To save on shunting personnel, a large number of 290s were converted to radio control from 1995. To allow a distinction between these locomotives and the non-converted ones, the series designation was increased from 290 to 294.

DELIVERY DATE: 2ND QUARTER 2017

Order no. 41568	Analog BASIC	Order no. 41570	Analog BASIC+	Energy Storage	Order no. 41572	Digital EXTRA	Digital Coupling	Energy Storage
Order no. 41571	Digital BASIC+	Energy Storage	Order no. 41573	Digital EXTRA	Digital Coupling	Energy Storage		

VI NEM 164,6 Rmin 360 PluX 22 2)

DB

Model: All axles are driven; all specific details of the 290, 291, 294, 295 and 296 ranges taken into account (e.g. different position of the fan, additional handrails and different bogie equipment); lights equipped with maintenance-free LEDs; chassis and gearbox housing manufactured from zinc die-casting; etched ventilator grille; spring buffers; free standing handles and handrails; clear view through the driver's cabin; light change; reproduction of the brake linkage; realistic presentation of the bogie frame incl. the axle drives



**Diesel Locomotive BR 295
"Hamburg" Metrans**
Road no. 9880 3295 092-1

DELIVERY DATE: 2ND QUARTER 2017

Order no. 41532	Analog BASIC	Order no. 41534	Analog BASIC+	Energy Storage	Order no. 41536	Digital EXTRA	Digital Coupling	Energy Storage
Order no. 41535	Digital BASIC+	Energy Storage	Order no. 41537	Digital EXTRA	Digital Coupling	Energy Storage		

VI NEM 164,6 Rmin 360 PluX 22 2)

METRANS

OVERVIEW OF ORDER NUMBERS AND TECHNICAL FUNCTIONS V90

Technical functions	BASIC	BASIC+		EXTRA	
	Analog Basic =	Analog BASIC+ =	Digital BASIC+ ~	Digital EXTRA =	Digital EXTRA ~
Driving function	+	+	+	+	+
Light change	+	+	+	+	+
Tail lights separately switchable		+ ¹⁾	+ ¹⁾	+	+
Driver cabin lighting		+ ¹⁾	+ ¹⁾	+	+
Shunting lights		+ ¹⁾	+ ¹⁾	+	+
Light setting programmable for analogue operation		+	+	+	+
Digital interface		PluX22	PluX22	PluX22	PluX22
Decoder			+	+	+
Sound				+	+
Energy storage		+ ^{1) 2)}	+ ²⁾	+ ²⁾	+ ²⁾
Driven fan motor				+	+
Digital Coupling (NEM-standard close coupling)				+	+
Additional information	Cannot be digitized				

¹⁾ Function only available in digital mode

²⁾ Storage capacitor for interruption-free travel in sections without current or on soiled tracks

It is possible to retrospectively convert the Diesel Locomotive V 90 from analogue to digital via a PluX22 interface (only sound functions). Please note that it is not possible to retrospectively convert the digital remotecontrol coupling, the driven fan or the additional light functions. For retrofitting of the product variant "Basic+" we recommend the electronic components on pages 94/95.





NEW ORIGINALS ON THE HORIZONT AND PERFECTLY-DETAILED MODELS

TWINDEXX VARIO® DOUBLE-DECK TRAIN DB REGIO AG











For many years now, double-decker trains have successfully formed the backbone of regional traffic. Doubledecker trains are the ideal solution, especially on routes with low platform lengths and a high volume of passengers. The tried-and-tested single-wagon concept of the TWINDEXX Vario® double-decker fleet is now being supplemented with an electrical railcar. Until today, DB Regio AG has ordered more than 50 of these Railcars in different configurations, as 4- 5- and 6-unit train versions. Each of these Railcars consist of two Motor cars and two to four middle cars. In Bavaria, the Main-Spessart-Express will operate in total twelve of these Railcars in the 4-Unit











version, all of them are going to be based in Würzburg. This railcar can be combined with additional middle wagons depending upon the application and desired capacity. The central buffer coupling enables operation with double traction and, as a result, the implementation of a wing-train concept. The trains are comfortably equipped with generous seat spacing and plenty of storage space. Furthermore, the double-decker individual wagons permit the extension and shortening of the block train and, consequently, an adjustment to fluctuating demand or future development. As a result, they can be utilised for the most diverse of operational applications in both regional traffic.



REPLICA OF THE ORIGINAL - RAINER ALBRECHT

1:87

	BASIC +		EXTRA	
	Analog BASIC+ =	Digital BASIC+ ~	Digital EXTRA =	Digital EXTRA ~
TWINDEXX Vario® Double-Deck Train Main-Spessart-Express, DB Regio, 3-unit Road no. follow (Content: 2 Railcars 2nd class, 1 Middle Wagon 1st / 2nd class)	Order no. 44500	Order no. 44501	 Order no. 44502	 Order no. 44503
       	DELIVERY DATE: 4TH QUARTER 2017			

TWINDEXX Vario® Double-Deck Middle Wagon Main-Spessart-Express, DB Regio Road no. follow (Addition to Double-Deck Train 44500 to 44503)	Order no. 44510	Order no. 44511	 Order no. 44512	 Order no. 44513
       	DELIVERY DATE: 4TH QUARTER 2017			

Technical functions	Analog BASIC+ =	Digital BASIC+ ~	Digital EXTRA =	Digital EXTRA ~
Light change (Control Car)	+	+	+	+
Tail lights separately switchable	+	+	+	+
Driver cabin lighting	+	+	+	+
Passenger compartment lighting (lower and upper deck)	not retrofittable	not retrofittable	+	+
Shunting lights	+ ¹⁾	+ ¹⁾	+	+
Long-distance headlights	+ ¹⁾	+ ¹⁾	+	+
Illuminated destination indicator	only front side	only front side	+	+
Light setting programmable for analogue operation			+	+
All lights settings dimmable			+	+
Digital interface	PluX22	PluX22	PluX22	PluX22
Decoder	Order no. 99800	+	+	+
Train control by brake section			+	+
TrainBUS and Current Conducting Coupler			+	+
Sound			+	+
Additional information	¹⁾ Function only available in digital mode • Cannot be equipped with interior lighting • Easy decoder installation		• Interior lighting in each wagon can be individually controlled with ZugBUS (train BUS) • Compatible with and programmable in all common digital systems (DCC, Motorola, SX1 and SX2)	

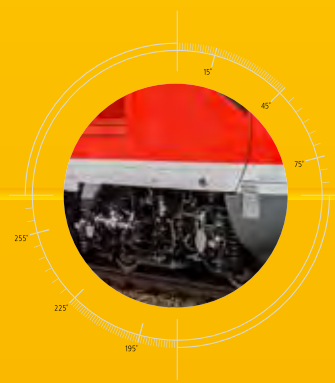

- Exactly scale 1:87
- True-to-original length over Scharfenbeck coupling
- Structure made of high-quality, impact-resistant plastic
- Metal bottom plate
- Printed window frames
- In-plane assembled windows
- Illuminated destination indicator (digital)
- Lighting with warm white LEDs

- Illuminated driver's cab
- True-to-scale details
- Extra mounted windscreen wiper
- Perfectly replicated three-dimensional front
- Multipart bogies
- Finest paintwork and printing
- With interior fittings, incl. driver's cab
- NEM-standard close coupling

- Lights change white/red, in the direction of travel
- Metal bearing
- ZugBus: automatic detection of the first and last model in the train; controlling and programming of all functions; detection of brake sections
- ZugBUS-Functions are only available in digital mode





INTERCITY 2 - TWINDEXX VARIO® DOUBLE-DECK COACHES FOR DB FERNVERKEHR AG

"IC 2" is the new name for the DB Fernverkehr AG TWINDEXX Vario® trains introduced following the timetable change on 13.12.2015. Back in 2010, Bombardier Transportation received the first order for 27 five-part double-deck trains in combination with the BR 146.5 locomotives from a previously-concluded framework contract with DB AG for a total of 800 double-deck trains. An order was placed for a further 17 trains in March 2015. The TWINDEXX Vario® is a further development of the tried-and-trusted double-deck platform from Görlitz. Each train has 468 seats, 70 of which are in 1st class as well as 10 bicycle parking spaces. The top speed

of the trains is 160 km/h. The IC 2 will gradually replace all previous IC trains in the new long-distance traffic concept from DB Fernverkehr AG. Following the timetable change, the first routes for these trains are Leipzig – Norddeich Mole, Dresden – Köln and Koblenz – Norddeich Mole. The BRAWA models of the TWINDEXX Vario® IC double-deck coaches can be ideally combined with the TRAXX BR 146.5 electric locomotive from DB AG (Order No. 43976 – 43979) to create a train that is true to the original. More information is available at www.brawa.de

	BASIC +		EXTRA	
	Analog BASIC+ =		Digital =	Digital ~
TWINDEXX Vario® IC 2-Double-Deck Coaches, 3-unit Road no. 50 80 86-81 873-1 / 50 80 26-81 402-2 / 50 80 26-81 469-1 (Content: 1 Control Car, 2 Middle Wagons 2nd Class)	Order no. 44504 ¹⁾		Order no. 44507	Order no. 44514
TWINDEXX Vario® IC 2-Double-Deck Middle Wagon 1st Class Road no. 50 80 16-81 171-5 (addition to 3-unit coaches 44504 or 44507/44514)	Order no. 44505 ²⁾		Order no. 44508	Order no. 44515
TWINDEXX Vario® IC 2-Double-Deck Middle Wagon 2nd class Road no. 50 80 26-81 468-3 (addition to 3-unit coaches 44504 or 44507/44514)	Order no. 44506 ²⁾		Order no. 44509	Order no. 44516
Technical functions	Analog =		Digital = / ~	
Light change (Control Car)	+		+	
Tail lights separately switchable	+ ³⁾		+	
Driver cabin lighting (Control Car)	+		+	
Passenger compartment lighting (lower and upper deck)	not retrofittable		+	
Shunting lights	+ ³⁾		+	
Long-distance headlights	+ ³⁾		+	
Destination indicator	+ at the front side		+	
All lights settings dimmable	+		+	
Digital interface (Control Car)	PluX22		PluX22	
Decoder (Control Car)			+	
TrainBUS and Current Conducting Coupler			+	
Sound			+ ⁴⁾	
Additional information	¹⁾ Necessary for AC operation: Replacement wheel set order no.: 2192, Decoder 99816 and AC pick-up 2222 (set no. 99817) ²⁾ Necessary for AC operation: Replacement wheel set order no.: 2192 ³⁾ Function only available in digital mode <ul style="list-style-type: none"> Cannot be equipped with interior lighting Easy decoder installation 		⁴⁾ Sound functions only in connection with a locomotive, e. g. BRAWA BR 146.5 order no. 43976 available <ul style="list-style-type: none"> Interior lighting in each wagon can be individually controlled with ZugBUS (train BUS) Compatible with and programmable in all common digital systems (DCC, Motorola, SX1 and SX2) 	



ORIGINALFOTO: RST

Recommended products: suitable for TRAXX Electric Locomotive BR 146.5 DB AG (Order no. 43976 – 43979)

INFORMATION ABOUT TRUE-TO-ORIGINAL COMBINATION OF TRAINS AT:
WWW.BRAWA.DE/TWINDEXX



1:87

- Exactly scale 1:87
- True-to-original length over buffer
- Structure made of high-quality, impact-resistant plastic
- Metal bottom plate
- Printed window frames
- In-plane assembled windows
- Illuminated destination indicator (digital)
- Lighting with warm white LEDs

- Illuminated driver's cab
- True-to-scale details
- Extra mounted windscreen wiper
- Perfectly replicated three-dimensional front
- Multipart bogies
- Finest paintwork and printing
- Functions and painting perfectly adjusted for BRAWA TRAXX Electric Locomotive BR 146.5

- With interior fittings, incl. driver's cab
- NEM-standard close coupling
- Lights change white/red, in the direction of travel
- Metal bearing
- ZugBus: automatic detection of the first and last model in the train; controlling and programming of all functions; detection of brake sections
- ZugBUS-Functions are only available in digital mode

TWINDEXX VARIO® IC 2-Double-Deck Coaches, 3-unit (Content: 1 Control Car, 2 Middle Wagons 2nd Class)
 Road no. 50 80 86-81 873-1 / 50 80 26-81 402-2 / 50 80 26-81 469-1



Analog BASIC +		Digital EXTRA =	Digital EXTRA ~
Order no. 44504		Order no. 44507	Order no. 44514
AVAILABLE		DELIVERY DATE: 2ND QUARTER 2017	

TWINDEXX VARIO® IC 2-Double-Deck Middle Wagon 1st Class (Addition to 3-unit coaches 44504 or 44507/44514)
 Road no. 50 80 16-81 171-5



Analog BASIC +		Digital EXTRA =	Digital EXTRA ~
Order no. 44505		Order no. 44508	Order no. 44515
AVAILABLE		DELIVERY DATE: 2ND QUARTER 2017	

TWINDEXX VARIO® IC 2-Double-Deck Middle Wagon 2nd Class (Addition to 3-unit coaches 44504 or 44507/44514)
 Road no. 50 80 26-81 468-3



Analog BASIC +		Digital EXTRA =	Digital EXTRA ~
Order no. 44506		Order no. 44509	Order no. 44516
AVAILABLE		DELIVERY DATE: 2ND QUARTER 2017	



Diesel Railcar VT62.9 DB
Road no. VT62 902

From the railcars with the 210 HP system, DB only renamed the VT137 127 into the VT62 902. DB utilised the VT62 902, initially starting from Bielefeld or Hamburg. The last of the eleven VB147 vehicles was only discontinued at the start of the 1970s.
AVAILABLE



Order no. 44374	Analog BASIC+	[Speaker icon]	Order no. 44376	Digital EXTRA	[Speaker icon]	[DCC icon]
Order no. 44375	Digital BASIC+	[Speaker icon]	Order no. 44377	Digital EXTRA	[Speaker icon]	[DCC icon]

Model: Extra mounted and free-standing metal handrails and steps; prepared for sound or with built-in sound; metal drive unit; multipart interior fittings; illuminated driver's cab and front light switchable; in-plane assembled windows; finest metal spoked wheels; metal reversing gear; drive to two axles; with interior lighting; fine rivets; short coupling kinematics; finely detailed bogies; true-to-epoch lighting

Diesel Railcar VT137 DR
Road no. VT137 007

The six VT137 002, 005, 006, 007, 012 and 013 units from the first delivery series that were all repaired stood on DR territory. The railcars that remained with DR continued to travel from Zittau in Upper Lusatia until the start of the 1960s. Ultimately, the increasingly absent spare parts lead to discontinuation. The last VT62 quit service in Braunschweig at the end of the 1950s.
AVAILABLE



Order no. 44378	Analog BASIC+	[Speaker icon]	Order no. 44380	Digital EXTRA	[Speaker icon]	[DCC icon]
Order no. 44379	Digital BASIC+	[Speaker icon]	Order no. 44381	Digital EXTRA	[Speaker icon]	[DCC icon]

Diesel Railcar VB147 DR
Road no. 147 014

DR has five VB in its inventory and uses them mainly in locomotive-drawn application with diesel locomotives. Initially, V36 were used (Halle/Usedom island), but they were later replaced by the BR V15, V23 and V60. The last of the VBs, designated BR 197 since 1970, operated until 1985 at Jerichow railway depot with a BR 110 locomotive.
AVAILABLE



Order no. **45150**

Model: Extra mounted and free-standing metal handrails and steps; finely detailed bogies; fine rivets; with interior lighting and tail lighting; with interior fittings; in-plane assembled windows; metal wheels.
If the sidecar has to be digitized, a function decoder BFD-01 (order no. 0014766.01) is necessary.
Replacement wheel set for AC (Order no. 0017383.00)



DEVIATING ROAD NO.



Order no. **45540**



Model: Wheel sets in toe bearing; originally reproduced, three-dimensional frame body; individually mounted axle box cover; brake shoes in wheel plane; extra mounted steps; separately mounted axle brake rod; extra mounted brake system and Wendler-Ventilators; true-original interior fittings; wheelchocks attached; true-to-epoch different spring buffers; fine engravings and rivets

Passenger Coach Civ-33 DB
Road no. 85 778 Ksl

DELIVERY DATE: 2ND QUARTER 2017

DEVIATING ROAD NO.



Order no. **45541**

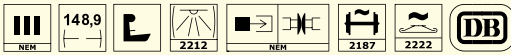

Passenger Coach Ci-33 DB
Road no. 85 871 Ksl

Thanks to their low dead weight, the wagons were primarily used in areas where it was only possible to transport low tensile loads due to gradients. Right into the 1960s, the Höllentalbahn ("Hell Valley Railway") from Freiburg to Neustadt and Seebugg was one of the most important routes. In addition to running behind railcars, the trailer cars also often ran with battery railcars. All classes suffered significant losses during the Second World War. DB primarily converted the Civ-33 into control cars for battery railcars. However, some vehicles remained that could only be used as trailer cars and there were also some control cars for railcars. Following the decommissioning of the last battery railcars, the remaining control cars were put into the railway carriage fleet once again and were decommissioned once the useful service life was over. DELIVERY DATE: 2. QUARTER 2017

1

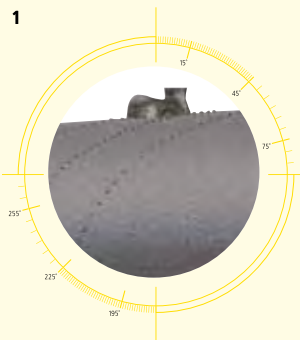

2

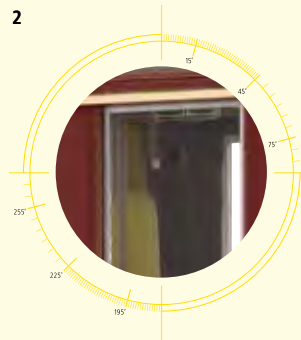

3

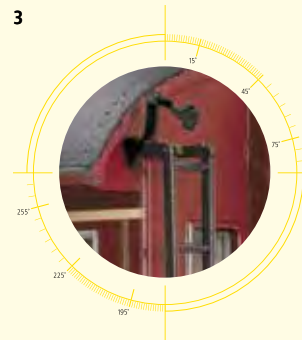

- 1_Replica of the rivets on the roof
- 2_In-plane assembled windows
- 3_Many extra mounted parts

(Pictures show order no 45541)



Sleeping Car C4üPWL DSG

Road no. 19104 Han

The war scattered express train wagons across half of Europe, with larger stocks outside German railway operators, for instance at ÖBB, SNCF and PKP. These wagons remained invaluable in regional transport for DB and DR up to the late seventies, reaching an age of over forty years. They were also used internationally up to the sixties, travelling as far as Scandinavia and the Balkans. There were many conversions, for instance into sleeping, dining, buffet and semi-luggage carriages. On the occasion of the anniversary in 1985, DB put together an entire train from several different types of express train wagons. Unfortunately, these wagons are today spread over several locations, and only a few of them are operable. DELIVERY DATE: 3RD QUARTER 2017



Order no. 46168

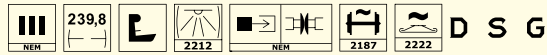

Model: True-to-epoch construction types; precise replica of the Görlitz III bogies with quadruple spring system; precise replica of the frame with many extra mounted parts; prepared for interior lighting; multipart interior fittings in multicolour painting; individual seats; short coupling kinematics; three-point support; wheelsets in toe bearing; replica of the rivets on the roof; in-plane assembled windows; metal wheels; precise replica of the brake unit; true-to-scale windows

Sleeping Car WL4ü-36/50 DSG

Road no. 19 110

DELIVERY DATE: 3RD QUARTER 2017



Order no. 46169

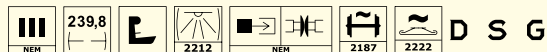

Gruppe 36



Order no. **46170**

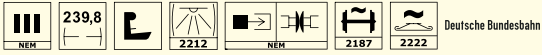

Company Coach WG4ü-36/50 DB
Road no. 74 454 Köl

DELIVERY DATE: 3RD QUARTER 2017

Model: True-to-epoch construction types; precise replica of the Görlitz III bogies with quadruple spring system; precise replica of the frame with many extra mounted parts; prepared for interior lighting; multipart interior fittings in multicolour painting; individual seats; short coupling kinematics; three-point support; wheelsets in toe bearing; replica of the rivets on the roof; in-plane assembled windows; metal wheels; precise replica of the brake unit; true-to-scale windows



Order no. **46171**



Company Coach WGye 831.1 DB
Road no. 50 80 89-53 705-6

DELIVERY DATE: 3RD QUARTER 2017

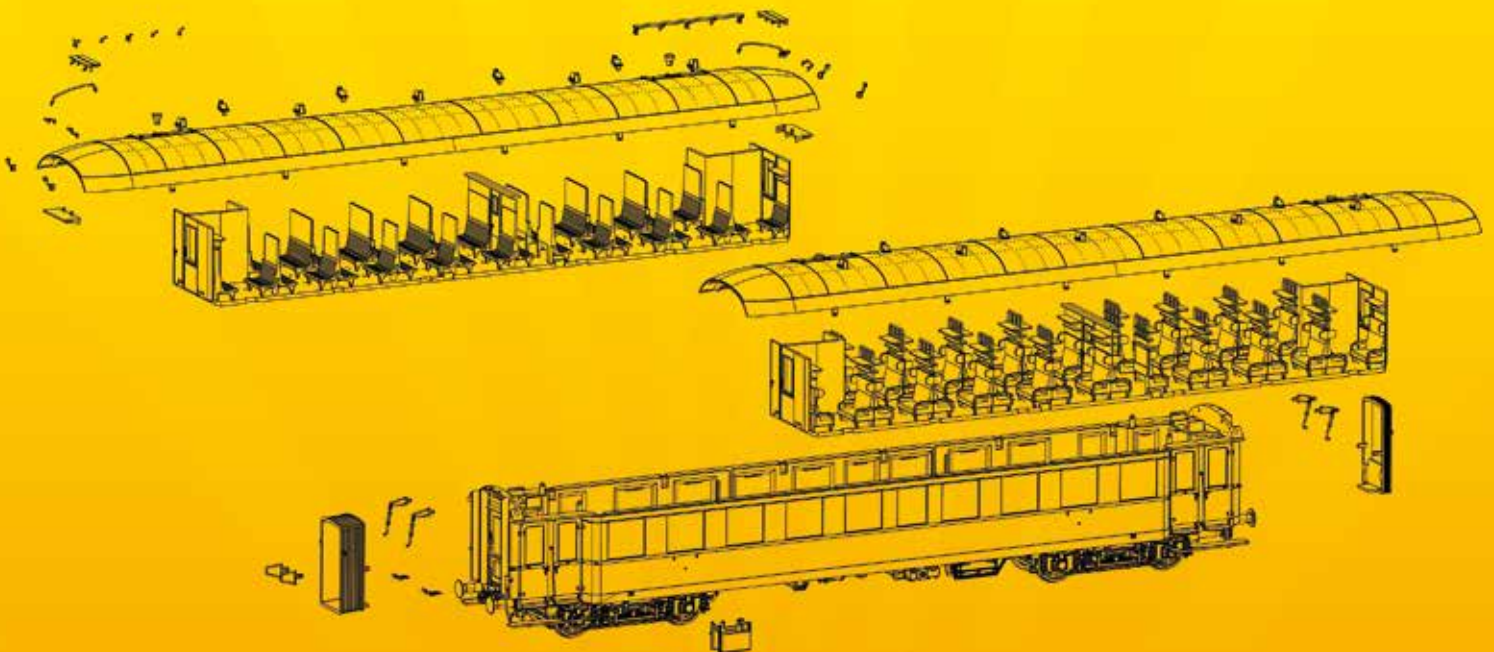

PERFECT REPLICAS OF THE ORIGINAL'S

Semi-Luggage Coach
APw4yse-36/54 DB
 Road no. 25 295 Hmb

DELIVERY DATE: 3RD QUARTER 2017



Order no. **46172**



Model: True-to-epoch construction types; precise replica of the Görlitz III bogies with quadruple spring system; precise replica of the frame with many extra mounted parts; prepared for interior lighting; multipart interior fittings in multicolour painting; individual seats; short coupling kinematics; three-point support; wheelsets in toe bearing; replica of the rivets on the roof; in-plane assembled windows; metal wheels; precise replica of the brake unit; true-to-scale windows

Semi-Luggage Coach ADyse 641 DB
 Road no. 50 80 81-11 003-5

DELIVERY DATE: 3RD QUARTER 2017



Order no. **46173**

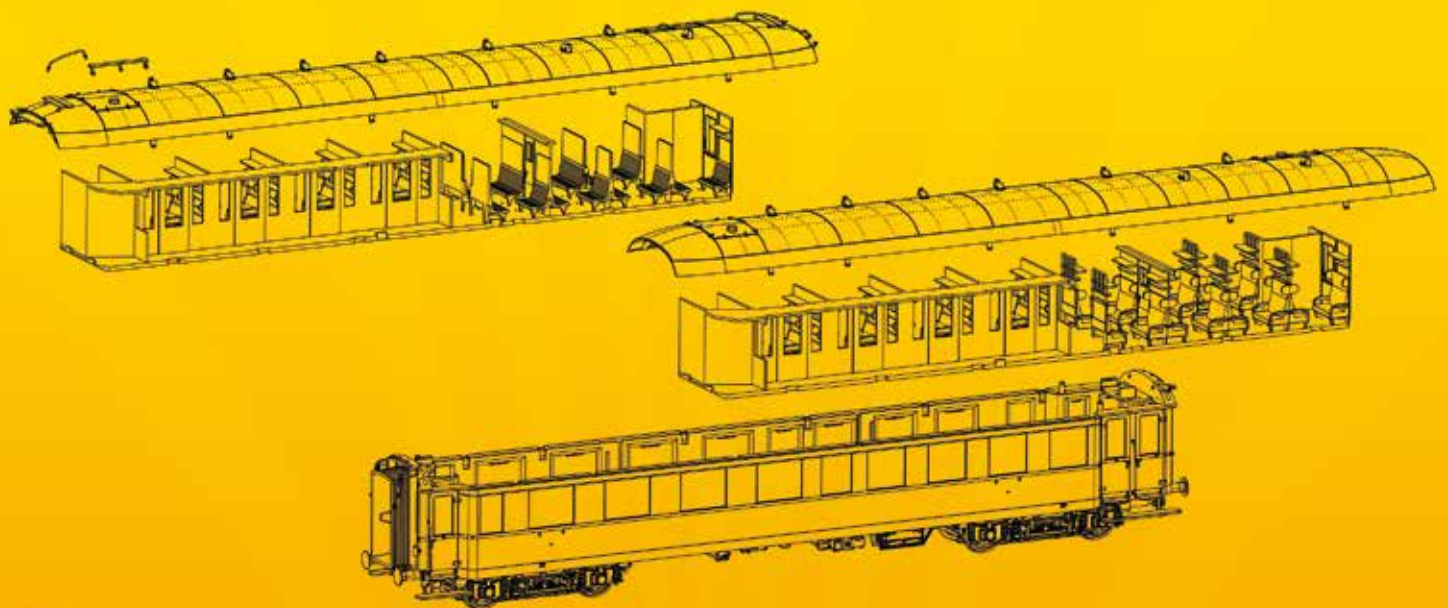
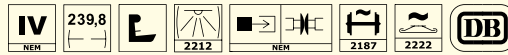

PERFECT REPLICAS OF THE ORIGINAL'S

Gruppe 36

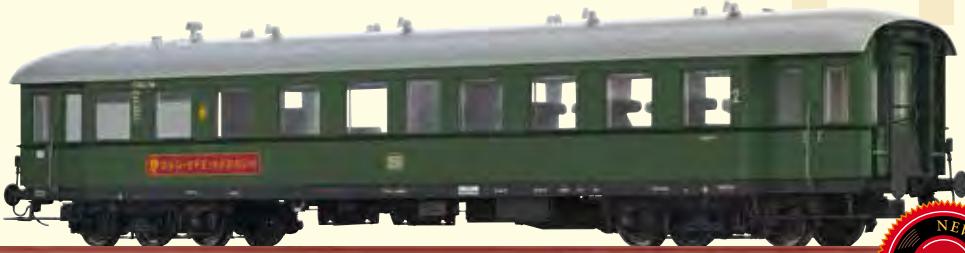

Order no. **46176**



Semi-Buffer Coach BR4ye-36/51 DB
Road no. 73 844 Ffm

DELIVERY DATE: 3RD QUARTER 2017

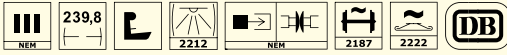

Model: True-to-epoch construction types; precise replica of the Görlitz III bogies with quadruple spring system; precise replica of the frame with many extra mounted parts; prepared for interior lighting; multipart interior fittings in multicolour painting; individual seats; short coupling kinematics; three-point support; wheelsets in toe bearing; replica of the rivets on the roof; in-plane assembled windows; metal wheels; precise replica of the brake unit; true-to-scale windows



Order no. **46179**



Semi-Buffer Coach BRye 693 DB
Road no. 50 80 85-11 026-2

DELIVERY DATE: 3RD QUARTER 2017

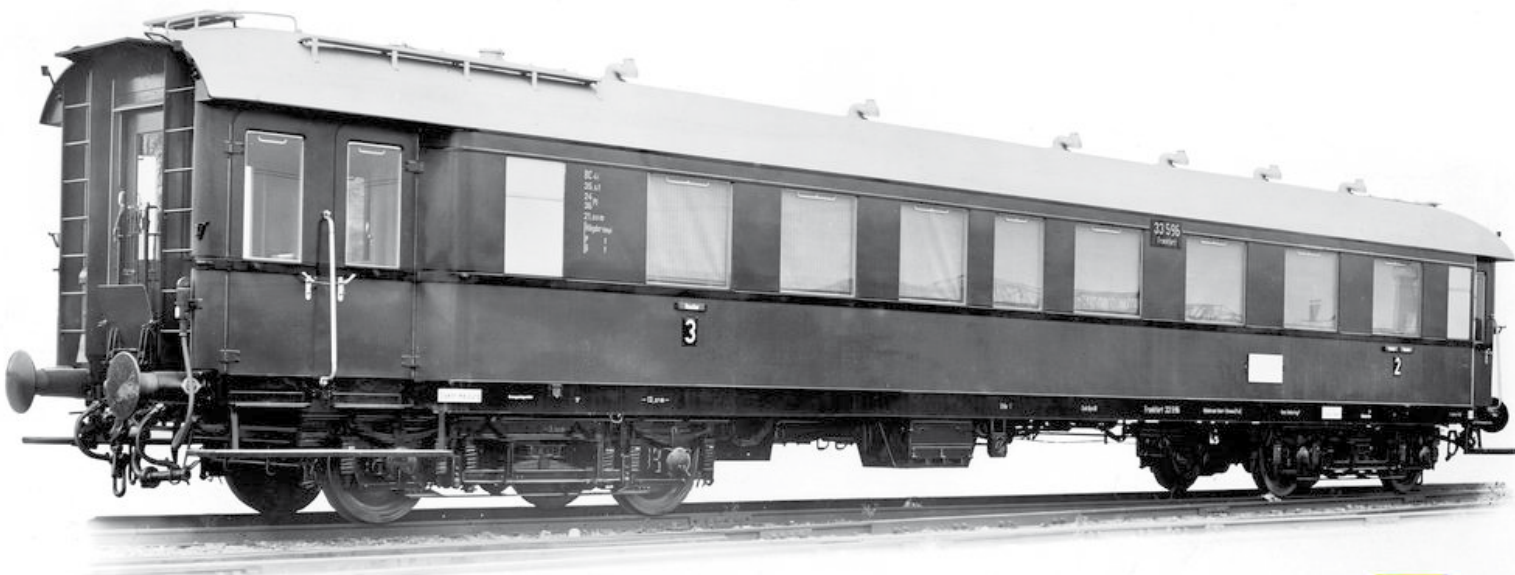
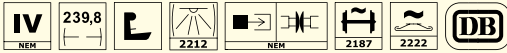

REPLICA OF THE ORIGINAL: RVM (WESTWAGGONG)



Passenger Coaches B3yge DB, set of 2

Road no. 50 80 23-11 102-6 Reg /
50 80 23-11 122-4 Reg

With the change-over to the new UIC numbering system valid from 1 January 1968, also 3yg-type wagons partly received new vehicle numbers suitable for EDP. Since sufficient modern n-type wagons were available in the vehicle fleet in the early seventies, the expectable remaining life of the 3yg-type wagons was easily assessable. Therefore the German Federal Railway (DB) implemented the new numbering system for the wagons only inconsistently. So, on all three subtypes, the main address field between the windows was indeed adjusted, and the vehicle number was placed centrally of the side panel, but on the AB3yg and BD3yg wagons, the old vehicle number was kept. From then on, the B3yg wagons travelled across the country with a modern EDP-suitable number.

DELIVERY DATE: 1ST QUARTER 2017



Order no. **46309**

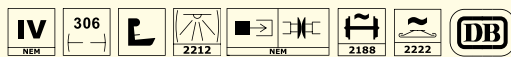

Model: Freestanding handrails; consideration of all frame differences for the AB3yg, B3yg and BPw3yg; true-to-original frame with many extra mounted parts; elastic rubber bulge; reproduction of the roof welding seams; freestanding brake system and car body supports; front side windows in the driver's department of the BPw3yg; prepared for interior lighting and tail light; short coupling kinematics; multipart interior fittings in multicolour painting; true-to-scale tail light; narrow frame to scale; in-plane assembled windows; metal tip bearing; reproduction of the step grille on all entrances; adjustable center axle



Order no. **46310**

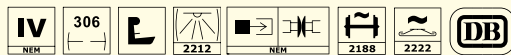

Passenger Coaches AB3yge and B3yge DB, set of 2

Road no. 37 249 Reg /
50 80 23-11 132-3 Reg

DELIVERY DATE: 1ST QUARTER 2017



Passenger Coaches B3yge and BD3yge DB, set of 2

Road no. 50 80 23-11 242-0 Reg /
99 520 Reg

DELIVERY DATE: 1ST QUARTER 2017



Order no. **46311**



3yg

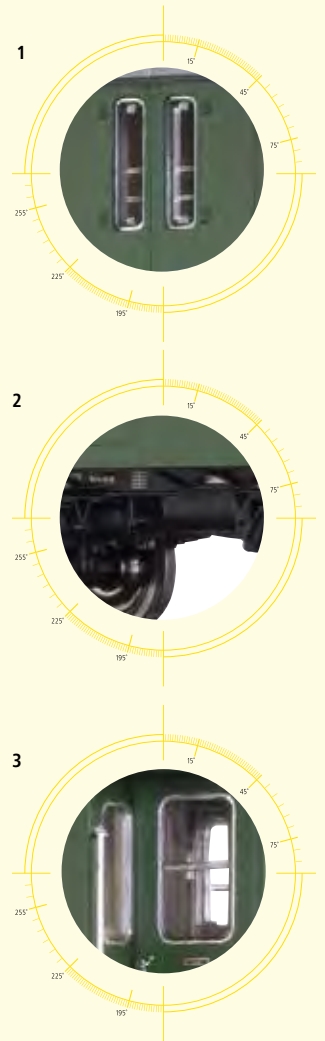

- 1_Consideration of all frame differences for the AB3yg, B3yg and BPw3yg
- 2_True-to-original frame with many extra mounted parts
- 3_Front side windows in the driver's department of the BPw3yg

(Photos show order no. 46311)





PASSENGER COACHES WITH VIENNESE CHARM AND EXCELLENT DETAILS

PASSENGER COACHES CU/CDU K.K.ST.B.

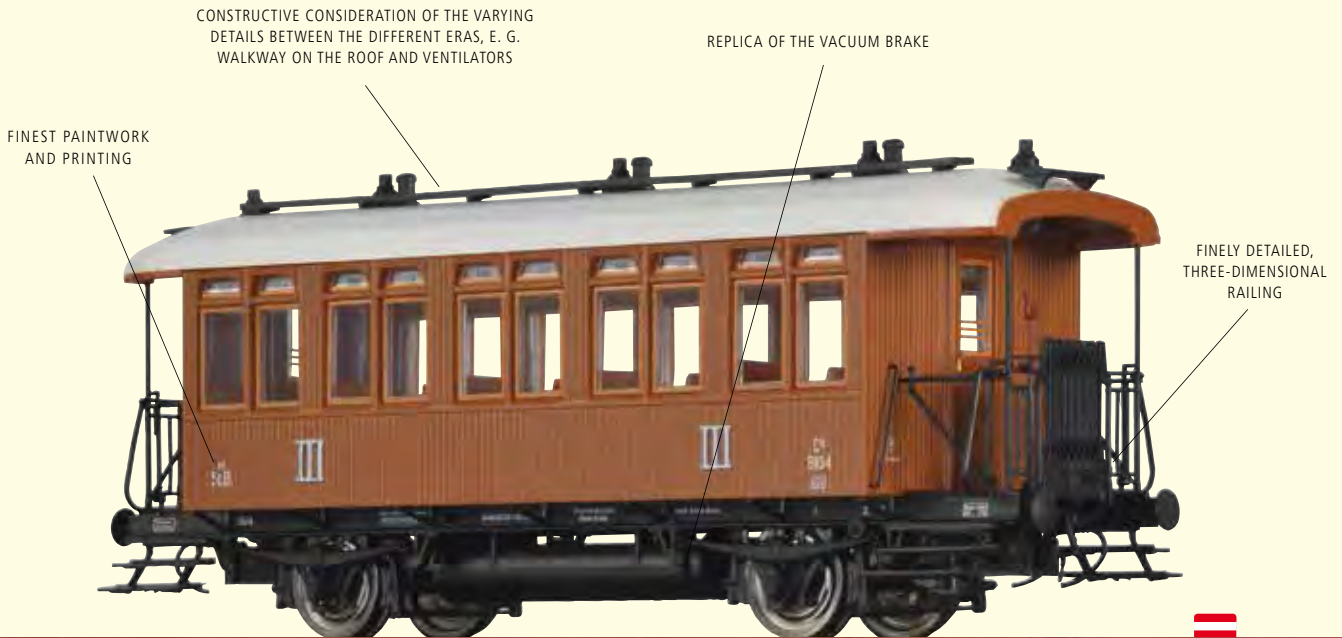

Passenger Coach Cu kkStB

Road no. 9104

After numerous plans and decades-long projects and discussions, the Vienna light railway was built from 1898. However, instead of the planned six lines, only four were built, covering a track length of some 39 km. The central government bore the lion's share of the cost, while the city of Vienna and the federal state of Lower Austria also contributed. As a reflection of this cost distribution, city planning considerations played only a subordinate role in construction. Instead, military strategies dominated. That is why there was neither a direct line into the centre, nor was electric traction used, even though the technology was already available then for urban transport. The track was built in standard gauge, and the railway was operated by k.k.Staatsbahn with steam locomotives. For the anticipated traffic, a total of 864 two-axle passenger train wagons of classes Cu and CDu were bought between 1896 and 1902. They featured a wheel base of 5,000 mm, a high, domed roof, steam

heating, vacuum brakes and a brown wooden exterior with characteristic double windows. This shape served as a model for many other passenger train wagons for local railways. Later, the roof ends were sometimes built straight and the wagon bodies received sheet metal paneling. After the city of Vienna leased and electrified part of the city railway, it also served regional traffic in the wider Vienna area. In 1941, both classes were adopted in the DRG number range and the numbers 206 541-207 117 (ex Cu) and 207 701-207 838 (ex CDu). Due to the events of the war, many wagons were spread over half of Europe, ending up after 1945 for instance with DR, and in Yugoslavia and Romania. As a representative of the original Vienna light railway, a Cu 9424 is today on display in the Vienna Technical Museum.

DELIVERY DATE: 2ND QUARTER 2017

Order no. **45643**



- Constructive consideration of the varying details between the different eras, e. g. walkway on the roof and ventilators
- Three-point support

- Perforated coach body supports
- Finely detailed, three-dimensional railing
- Short coupling kinematics

- Replica of the vacuum brake





REPLICA OF THE ORIGINAL: SLG. H. HELESS

Passenger Coach Cu kkStB
Road no. 9007



Order no. **45644**

I	114,9	L	2212	2187	2222	NEB
---	-------	---	------	------	------	-----

DELIVERY DATE: 2ND QUARTER 2017

Passenger Coach Bu ÖBB
Road no. 47 162



Order no. **45645**

III	114,9	L	2212	2187	2222	NEB	ÖBB
-----	-------	---	------	------	------	-----	------------

DELIVERY DATE: 4TH QUARTER 2017

Passenger Coach Bu ÖBB
Road no. 47 104



Order no. **45646**

III	114,9	L	2212	2187	2222	NEB	ÖBB
-----	-------	---	------	------	------	-----	------------

DELIVERY DATE: 4TH QUARTER 2017

Passenger Coach Cu BBÖ
Road no. 47 042



Order no. **45649**

III	114,9	L	2212	2187	2222	NEB	B B Österreich
-----	-------	---	------	------	------	-----	-----------------------

DELIVERY DATE: 2ND QUARTER 2017

Passenger Coach Cu BBÖ
Road no. 47 101



Order no. **45650**

III	114,9	L	2212	2187	2222	NEB	B B Österreich
-----	-------	---	------	------	------	-----	-----------------------

DELIVERY DATE: 2ND QUARTER 2017

Passenger Coach Cu CSD
Road no. 35-521



Order no. **45651**

II	114,9	L	2212	2187	2222	NEB	ČSD
----	-------	---	------	------	------	-----	------------

DELIVERY DATE: 2ND QUARTER 2017



Passenger Coach F4 SBB

Road no. 18792

Together with the four-axle passenger train coaches, luggage cars of a corresponding design were also purchased. These were also taken over by the SBB on nationalisation but disappeared from the stock much faster than the passenger coaches. However, due to their large storage space, they were extremely suitable as service cars and for stationary use as a store. In contrast to Germany, a four-axle coach of American type remained in Switzerland. The BC4 with the number 4952 was renovated and can be inspected today in the Swiss Transport Museum in Lucerne. AVAILABLE



Order no. 45058

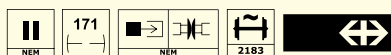

Model: Handles and steps in lower-density material; extra gas tank; completely lacquered wagon body, housing and roof with soot marks; tip bearing wheelsets; true-to-scale side frames; extra wheel bearing and suspension system

Passenger Coach BC4 SBB

Road no. 4813

Not only the Royal Württemberg State Railway Company but also several formerly private railways in Switzerland purchased four-axle vestibule coaches based on the "American system". Around 300 of these coaches were still in existence and taken over by the Swiss National Railway Company when it was founded in 1902. These coaches were operated on Swiss National Railway Company routes for around 40 years. Many passenger trains were put together out of old coach material. It was not until 1941 that the last of these coaches, which were by then 82 years old, disappeared from the Swiss National Railway Company's tracks, although some of the smaller private railways, such as the Oensingen Balsthal Railway Company, continued to use them for several years more! AVAILABLE



Order no. 45059



Passenger Coach C4 SBB

Road no. 8765

AVAILABLE



Order no. 45060

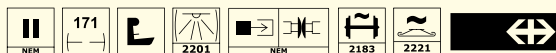





ACCOMPANYING WAGONS WITH THRILLING DETAILS

FREIGHT CAR PWG 14 P.St.E.V.



LAYOUT VERSION



Freight Car Pg 14 P.St.E.V.
Road no. Osten 4021

P.St.E.V.

Up to the twenties of the previous century, goods trains of all German railway administrations were operated with manual brakes. In addition to the locomotive personnel, the crew of the train therefore included a chief train conductor as the highest authority, a master packer, train conductor and shunter as well as several brakeman. These persons were responsible for braking the train, for the shunting work during stops en route, and the exchange and processing of freight documents of the transported goods. For this purpose, a special accompanying wagon was carried along behind the locomotive that served as a rolling working and recreation place. Only the brakeman had to stay in one of the brakeman's cabins during the trip. Completing the own development, the KPEV (Royal Prussian Railway Administration) procured luggage wagons ("Pwg") according to master drawing pr Ila 13a for the first

time in 1913/14. After the end of World War I, this design was selected as replacement of the old or missing accompanying wagons of the most German Länder railway operators. So, over 7,000 "Pwg" were built according to the 2nd revised edition of the master drawing until 1929 and spread not only in the former KPEV region, but also in Baden, Bavaria, Wuerttemberg, and Saxony. Starting at the end of the thirties, the DRB removed the through-going running boards and handlebars, allegedly due to an attempted robbery of a train. Additional structural alterations even before the outbreak of the war included reinforcements of the wagon body frame and the removal of the window in the storage space door.

DELIVERY DATE: 4TH QUARTER 2017

Order no. **49400**



- Wheelsets in toe bearing
- Bogie with three-point support
- Originally reproduced, three-dimensional frame body
- Individually mounted axle box cover

- Brake blocks in wheel plane
- Extra mounted handrails and steps
- Extra mounted axle brake frame
- Extra braking system
- Perforated coach body supports

- Era-conforming realisation such as through-going and separated steps, gas or electric lighting, without or with diagonal stiffening





LAYOUT VERSION



Order no. **49401**

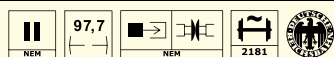

Freight Car Pwg pr 14 DRG

Road no. 95 341 Mainz

DELIVERY DATE: 4TH QUARTER 2017

LAYOUT VERSION



Order no. **49402**

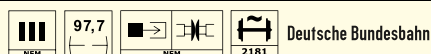

Freight Car Pwg pr 14 DB

Road no. 120 001 Mz

DELIVERY DATE: 4TH QUARTER 2017

LAYOUT VERSION



Order no. **49403**



Freight Car Pwg pr 14 DB

Road no. 123 312 Nür

After the war, the DB reinforced their "Pwg pr 14" wagons according to prima facie uniform criteria. Nevertheless, this resulted in many differences so that no wagon resembled the other. Up to the early sixties, there were still also wagons with an unchanged body frame. At this time, however, the design type was already past its best. While around 2,700 wagons were counted in 1957, which were more than 50% of the "Pwg" stock, there were only a little over thousand left in 1961 and 201 in 1965. The last ones were used until 1972, but did not receive EDP-suitable wagon numbers anymore.
DELIVERY DATE: 4TH QUARTER 2017



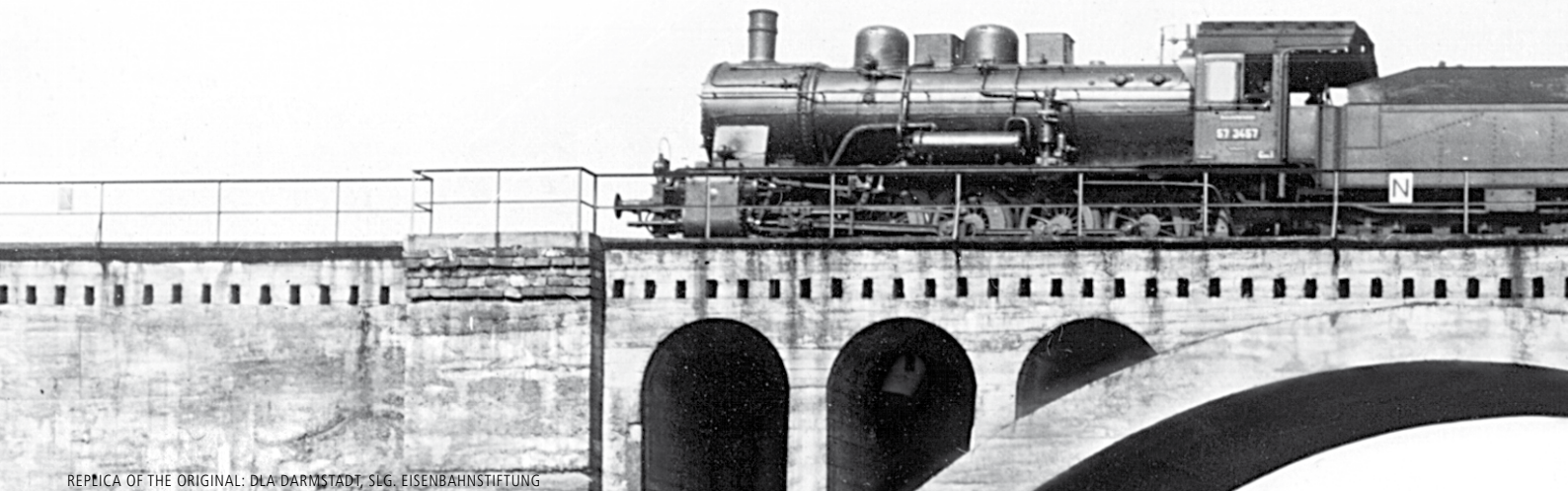

REPLICA OF THE ORIGINAL: DLA DARMSTADT, SLG, EISENBAHNSTIFTUNG

Freight Car Pwg pr 14 DR

Road no. 88-74-47

Also the East German Deutsche Reichsbahn (DR) reinforced the wagon body of their "Pwg", but had more self-control regarding the diversity of variants than the responsible DB people, and they even built the standardised "Pwg" body upon the undercarriages of other wagons. Partly, the wagons were equipped with roller bearing wheel sets and new axle holders. The last of these old models were still in use up to the early nineties. At that time, for many years already, also the DR had no more trains that were accompanied by a chief train conductor, but due to the numerous railway stations and private siding tracks with goods traffic, a wagon for the co-travelling shunting personnel of the short-distance goods trains was needed in many places. DELIVERY DATE: 4TH QUARTER 2017

LAYOUT VERSION



Order no. 49411

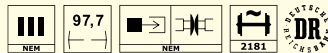

Model: Wheelsets in toe bearing; bogie with three-point support; originally reproduced, three-dimensional frame body; individually mounted axle box cover; brake blocks in wheel plane; extra mounted handrails and steps; extra mounted axle brake frame; extra braking system; perforated coach body supports; era-conforming realisation such as throughgoing and separated steps, gas or electric lighting, without or with diagonal stiffening

ČSD

Freight Car D CSD

Road no. 6-2458

DELIVERY DATE: 4TH QUARTER 2017

LAYOUT VERSION



Order no. 49406





BB
Österreich



Freight Car Pwg pr 14 BBÖ
Road no. 75 117

DELIVERY DATE: 4TH QUARTER 2017

LAYOUT VERSION

Order no. **49408**



Model: Wheelsets in toe bearing; bogie with three-point support; originally reproduced, three-dimensional frame body; individually mounted axle box cover; brake blocks in wheel plane; extra mounted handrails and steps; extra mounted axle brake frame; extra braking system; perforated coach body supports; era-conforming realisation such as throughgoing and separated steps, gas or electric lighting, without or with diagonal stiffening



SNCF



Freight Car M SNCF
Road no. 935 038

DELIVERY DATE: 4TH QUARTER 2017

LAYOUT VERSION

Order no. **49409**

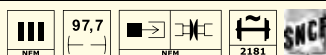



MOST BEAUTIFULLY DESIGNED AUXILIARY LUGGAGE WAGONS

L U G G A G E C A R M D Y G D B

Due to the great lack of travel wagons and express train wagons following World War 2 and the generally poor condition of the vehicle fleet, a conversion campaign for four-axle wagons was announced as early as the presentation of the three-axle conversion wagons. In terms of design, the development of the 4yg wagons was very closely linked to the 3yg wagons which lead to the assumption of numerous components. Therefore, the similarity of both wagon types is unmistakable. However, the 4yg wagons were given a central entrance that had already proven itself with the new 26.4 m city express train wagons and lead to a symmetrical distribution. The majority of donor wagons were Prussian-type 4-axle compartment wagons. The vehicle frames of the donor wagons were all brought to a uniform length of 19,460 mm and then firmly attached to the new steel construction. The first trial wagons were delivered in 1955 by Aw Hannover [Hanover Railway Workshop]. In the subsequent years up to the start of the 1960s, over 1800 wagons of the

three main categories, AB4yg, B4yg and BPw4yg, were manufactured. Refurbished standard Prussian design bogies as well as swan-neck bogies were used for the wagons manufactured up to 1958. After 1958, the newly-developed light Minden-Deutz bogies were installed. In order to ensure independent utilisation with all three types of traction, all wagons were equipped with both steam and electric heating. Due to the late delivery of the AB4yg, it was not possible to create trains of a single type from the start. For this reason, A or AB pre-war express train wagons were usually deployed in trains made up of B4yg wagons until 1958. In doing so, the wagons were distributed across the whole of Germany. However, the actual plan of withdrawing all wagons from service by 1.1.1990 did not come to fruition as reunification caused an increase in the demand for wagons. As a result, some wagons even made it as far as Berlin. The last 4yg wagons were finally withdrawn from the Deutsche Bahn fleet on 28.2.1994.



REPLICA OF THE ORIGINAL: P. SCHIFFER, SLG, EISENBahnSTIFTUNG



Luggage Car Mdyg 986 DB

Road no. 50 80 92-11 491-9 Han



LAYOUT VERSION

Order no. **46253**



Model: With wooden walls

DELIVERY DATE: 2ND QUARTER 2017

Luggage Car Mdyg 986 DB

Road no. 50 80 92-11 326-7



LAYOUT VERSION

Order no. **46255**

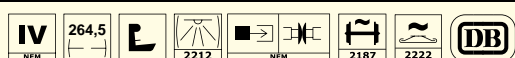

Model: With slab walls and double windows; with closed transitions

DELIVERY DATE: 2ND QUARTER 2017



- All handles are free-standing
- Precise replica of the frame with many extra mounted details
- Extra mounted battery box
- Finely detailed, three-dimensional bogie
- Free-standing brake system
- Prepared for interior lighting
- Short coupling kinematics
- Multipart interior fittings in multicolour painting
- In-plane assembled windows
- Reproduction of internal mesh of the windows
- Metal tip bearing
- True-to-original replica of the brake unit

Recommended products: suitable for Passenger Coaches 4yg, Express Train Coaches, Passenger Coaches 3yg and Diesel Locomotive BR 212 / 213 / 216 DB



Covered Freight Car G10 DB
Road no. 141 366



Tariff conditions on the one hand and technical conditions on the other resulted in all State railway administrations developing box cars with almost identical dimensions and payloads. These cars had a 4.5 m wheelbase, a length over buffers of 9.3 m for unbraked cars, a payload of 15 t, later 17 t and a floor area of approx. 21 square metres. This type of freight construction became the most important and most built box car; it originally had the type identifier Gm.

The most common of these State railway cars, which numbered 47,533, were built according to the Prussian style sheet IId8. After the founding of the Deutscher Staatsbahn Wagen Verband (German state railway car federation) DWV in 1909, the federation car construction type A2 was developed from this.

From 1911 a phenomenal total of 121,770 units were built, making it the most heavily produced box car. It dominated the image of the German goods trains until the early days of the third era. These cars were scattered all over Europe by two world wars, there were no European railway administrations where this type of car was not used at least temporarily.

DELIVERY DATE: 3RD QUARTER 2017

Order no. **49713**



- Metal pedestal tie bars, metal axles
- Extra signal holders
- Separately mounted axle box cover
- Finest paintwork and printing
- Close coupling
- Wheelsets in toe bearing
- Extra mounted steps and handrails in low-material thickness
- Multi-part brake system with brake shoes in wheel plane
- Undercarriage with brake systems

Covered Freight Car G DR
Road no. 05-19-69



Order no. **49712**

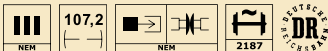

DELIVERY DATE: 3RD QUARTER 2017

Covered Freight Car G10 SNCB / EUROP
Road no. 296691



Order no. **49077**





AVAILABLE



Covered Freight Car G10 "Nivea" DRG
Road no. 528 798 [P]





Order no. **49032**   

DELIVERY DATE: 3RD QUARTER 2017

Covered Freight Car G10 "Hansaplast" DB
Road no. 127 087





Order no. **49035**   

AVAILABLE

Covered Freight Car G10 "Berentzen Traditionskorn" DB
Road no. 125 334





Order no. **49045**   

DELIVERY DATE: 3RD QUARTER 2017

Covered Freight Car G10 "Maggi" DB
Road no. 126 534





Order no. **49070**   

AVAILABLE

Covered Freight Car G10 "Fritz Homann" DB
Road no. 525 330 [P]



Order no. **49074**   

AVAILABLE

Covered Freight Car G10 "Doornkaat" DB
Road no. 135 398





Order no. **49091**   

DELIVERY DATE: 3RD QUARTER 2017

Covered Freight Car G10 "Felix" DB
Road no. 136 350





Order no. **49711**   

DELIVERY DATE: 3RD QUARTER 2017

Covered Freight Car Kuwf A.L.
Road no. 314.466





Order no. **49094**   

DELIVERY DATE: 3RD QUARTER 2017



Covered Freight Car G10 "Zwanenberg" NS
Road no. 555 361 [P]





Order no. **49061**    **NS**

DELIVERY DATE: 3RD QUARTER 2017

Covered Freight Car G10 "Amstel Brouwerij N.V." NS
Road no. 560 016 [P]





Order no. **49062**    **NS**

DELIVERY DATE: 3RD QUARTER 2017

Covered Freight Car SS "Boterverkoop" NS
Road no. 1002 [P]



Order no. **49064**    **NS**

AVAILABLE

Covered Freight Car Z CSD
Road no. 1.47307



Order no. **49067**    **ČSD**

DELIVERY DATE: 3RD QUARTER 2017

Covered Freight Car Gg "Cosmanos" CSD
Road no. 1.0004 [P]



Order no. **49092**    **ČSD**

DELIVERY DATE: 3RD QUARTER 2017

Covered Freight Car Gb "Prior" CSD
Road no. 221-514 [P]



Order no. **49093**    **ČSD**

DELIVERY DATE: 3RD QUARTER 2017

Covered Freight Car G BBÖ
Road no. 79 167





Order no. **49071**    **BB Österreich**

DELIVERY DATE: 3RD QUARTER 2017

Covered Freight Car G "Kaiser Bier" ÖBB
Road no. 560 411 P







Order no. **49084**    **ÖBB**

DELIVERY DATE: 3RD QUARTER 2017



Tank Car ZZ [P] DRG
Road no. 501 493 [P]







Order no. **47402**     

DELIVERY DATE: 2ND QUARTER 2017

Tank Car ZZ [P] "LEUNA" DR
Road no. 52-97-38 [P]







Order no. **47403**     

DELIVERY DATE: 2ND QUARTER 2017

Refrigerator Car UIC Standard 1 Ibces "Interfrigo" FS
Road no. 14 83 083 2 106-3







Order no. **48334**     

AVAILABLE

Refrigerator Car UIC Standard 1 Ibces "Interfrigo" DB
Road no. 11 80 083 0 021-2 [P]







Order no. **48338**     

DELIVERY DATE: 2ND QUARTER 2017

Refrigerator Car UIC Standard 1 Hlv „BADOIT" SNCF
Road no. 525 015 [P]







Order no. **48339**     

DELIVERY DATE: 2ND QUARTER 2017

Refrigerator Car UIC Standard 1 Ibces "STEF" SNCF
Road no. 11 87 082 7 051-7 [P]







Order no. **48341**     

DELIVERY DATE: 2ND QUARTER 2017

Refrigerator Car UIC Standard 1 „Interfrigo" NS
Road no. 26 656



Order no. **48343**     

DELIVERY DATE: 2ND QUARTER 2017



Finest details from every angle
Discover all 360°-views from BRAWA





TRANSPORT TALENT FOR BULK GOODS

OPEN FREIGHT CAR OTMM 70 DB

In order to achieve a larger loading space of 40 m³, the undercarriage and the wheel base of the previous Otmm wagons were extended by 500 mm. The first of these wagons with a capacity of 40 m³ was built by the Paderborn railway repair shop on a trial basis in 1961. The design stood the test, and so the railway repair shops of Kaiserslautern and Weiden built more than 16,000 Otmm 70/Ed 090 wagons between 1961 and 1970, also using profiles of old but usable Omm 37 wagons. The wagons - referred to as Fc 090 from 1980 onwards - ran as single wagons and in block trains with bulk goods of all kinds. A shortage of hinged roof wagons led to the fact

that they were also covered with tarpaulins and used for the transport of cereals. Consequently, 1,500 wagons were equipped with hinged roofs in 1978/79 and referred to as Tdgs-z 932. Many other wagons received a load alteration switchover and were referred to as Fcs 090 or, after being adapted for further operation from 1991 onwards, as Fcs 092. In 1994, the DB AG took over even more than 8,500 Fc(s) 090 wagons which were decommissioned until 2007. In 2012, around 2,600 of the Fcs 092 wagons were still in service, another 786 wagons were used as Fcs-x 092 in coal transport.



- Wheelsets in toe bearing
- Bogie with three-point support
- Originally reproduced, three-dimensional frame body

- Individually mounted axle box cover
- Brake blocks in wheel plane
- Extra mounted handrails and steps

- Extra mounted axle brake frame
- Extra braking system
- NEM close coupling



REPLICA OF THE ORIGINAL: F. WILKE, SLG. S. CARSTENS



REPLICA OF THE ORIGINAL: F. WILKE, SLG. S. CARSTENS

Order no. **49500**



**Open Freight Car Otmm 70 DB,
set of 3**

Road no. 645 174/645 394/646 230

DELIVERY DATE: 1ST QUARTER 2018

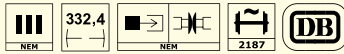

REPLICA OF THE ORIGINAL: F. WILKE, SLG. S. CARSTENS

Order no. **49501**



**Open Freight Car Ed 090 DB,
set of 3**

Road no. 21 80 542 3 040-6/

21 80 542 3 156-6/21 80 542 6 899-6

DELIVERY DATE: 1ST QUARTER 2018

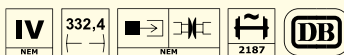

REPLICA OF THE ORIGINAL: H. EIDELST, SLG. S. CARSTENS

Order no. **49502**



Open Freight Car Fcs 092 DB AG

Road no. 01 80 646 1 787-3

DELIVERY DATE: 1ST QUARTER 2018





Open Freight Car Fcs 092 DB AG
Road no. 21 80 6458 876-5

DELIVERY DATE: 1ST QUARTER 2018



REPLICA OF THE ORIGINAL: D. LEHMANN

Order no. **49503**



Open Freight Car Eds-u Ommstu DR, set of 3
Road no. 21 50 550 0045-3 /
21 50 550 0352-3 / 21 50 550 0555-1

DELIVERY DATE: 1ST QUARTER 2018



REPLICA OF THE ORIGINAL: F. WILLKE, SLG. S. CARSTENS

Order no. **49504**

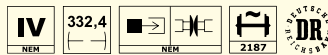

Open Freight Car Eds ÖBB, set of 3
Road no. 01 81 550 0 992-3 /
01 81 550 1 912-6 / 01 81 550 0 807-3

DELIVERY DATE: 1ST QUARTER 2018



REPLICA OF THE ORIGINAL: F. WILLKE, SLG. S. CARSTENS

Order no. **49505**



NS



REPLICA OF THE ORIGINAL: F. WILLKE, SLG. S. CARSTENS



Open Freight Car Fds NS
Road no. 50081

DELIVERY DATE: 1ST QUARTER 2018

Order no. **49506**

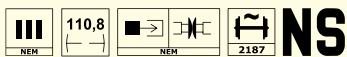

CFL



REPLICA OF THE ORIGINAL: F. WILLKE, SLG. S. CARSTENS



Open Freight Car Eds CFL
Road no. 01 82 550 5 247-6

DELIVERY DATE: 1ST QUARTER 2018

Order no. **49507**



B



REPLICA OF THE ORIGINAL: F. WILLKE, SLG. S. CARSTENS



Open Freight Car Eds
Type 1000 E2 SNCB
Road no. 01 88 550 5 539-0

DELIVERY DATE: 1ST QUARTER 2018

Order no. **49508**



Tank Car Z [P] "VTG" DB
Road no. 589 735 [P]







Order no. **49222**    

DELIVERY DATE: 2ND QUARTER 2017

Tank Car Z [P] DRG
Road no. Halle 904 888 [P]







Order no. **49221**    

DELIVERY DATE: 2ND QUARTER 2017

Tank Car Z [P] "Albizol/Monopolin" DRG
Road no. Berlin 591 323 [P]



Order no. **49225**    

DELIVERY DATE: 2ND QUARTER 2017

Tank Car Z [P] "ESSO" DB
Road no. 23 80 703 2 015-1 [P]







Order no. **49224**    

DELIVERY DATE: 2ND QUARTER 2017

Tank Car Z [P] "VEB Bitterfeld" DR
Road no. 25 50 715 8647-3 [P]



Order no. **49223**    

DELIVERY DATE: 2ND QUARTER 2017



Tank Car SCwf "Locataire Naphtachimie" SNCF
Road no. 7573826 [P]



Order no. **49217**

DELIVERY DATE: 2ND QUARTER 2017

Tank Car SCwf "Simonra/ESSO" SNCF
Road no. 7596113 [P]



Order no. **49219**

AVAILABLE

Tank Car SCwf "Lambiotte" SNCF
Road no. 569543 [P]



Order no. **49229**

DELIVERY DATE: 2ND QUARTER 2017

Tank Car Z [P] "Stroh & Co." ÖBB
Road no. 21 81 001 1 427-9 [P]



Order no. **49226**

DELIVERY DATE: 2ND QUARTER 2017

Tank Car Z [P] "Staatsmijnen" NS
Road no. 515615 [P]



Order no. **49227**

DELIVERY DATE: 2ND QUARTER 2017

Tank Car Z [P] "Nieuwe Matex" NS
Road no. 510128 [P]



Order no. **49228**

DELIVERY DATE: 2ND QUARTER 2017

Tank Car R [P] CSD
Road no. 8-72249 P







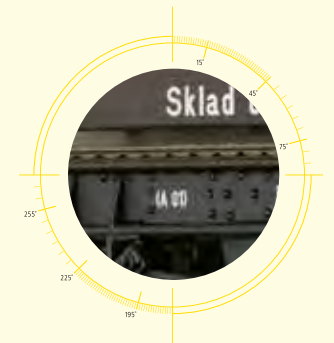
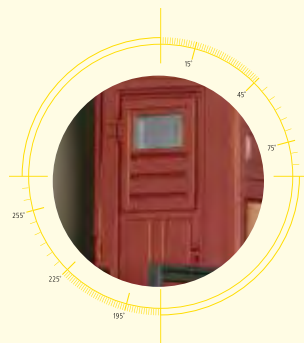

Order no. **48887**

DELIVERY DATE: 2ND QUARTER 2017



Covered Freight Car Hbis 297 DB
Road no. 21 80 211 7 994-8









Order no. **48985**      

DELIVERY DATE: 3RD QUARTER 2017

Covered Freight Car Hbis 299 "Kaldewei" DB
Road no. 21 80 211 6 534-4









REPLICA OF THE ORIGINAL: F. WILKE, SLG. S. CARSTENS

Order no. **48984**      

DELIVERY DATE: 3RD QUARTER 2017

Covered Freight Car Hbis „Gösser Bier“ ÖBB
Road no. 21 81 211 6 005-3



Order no. **48983**      

DELIVERY DATE: 3RD QUARTER 2017

Covered Freight Car Hbis „Post“ DSB
Road no. 46 86 225 0 440-4



Order no. **48978**      

AVAILABLE

Covered Freight Car Hbis "Grand Danois" DSB
Road no. 21 86 225 0 209-2









Order no. **48979**      

AVAILABLE



Rail Car SS1a DRG
Road no. Köln 15 582









Order no. **47218**      

AVAILABLE

Rail Car SS1ma 44 DB
Road no. 21 80 380 0 416-3



Order no. **47219**      





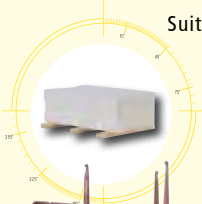

AVAILABLE

Stake Car Rmms FS
Road no. 31 83 395 9 085-9



Suitable load: Marble Block
Order no. 94702 (see page 75)









Order no. **47114**       

DELIVERY DATE: 2ND QUARTER 2017

Stake Car Rmms TSS
Road no. 83 54 3959 066-2









Order no. **47115**       

DELIVERY DATE: 2ND QUARTER 2017

Flat Car Samm [4818] DR, set of 3
Road no. 31-50-486 7317-4/31-50-482 0388-1/31-50-486 7578-1









Order no. **47500**      

DELIVERY DATE: 2ND QUARTER 2017

Flat Car Samm-u 453 DB AG
Road no. 31 80 482 0 026-1



Order no. **47501**      





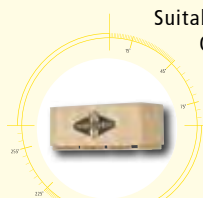

DELIVERY DATE: 2ND QUARTER 2017

Flat Car RRym DR
Road no. 60-21-35



Suitable load: Wooden Box
Order no. 94701 (see page 75)



Order no. **47502**      

DELIVERY DATE: 2ND QUARTER 2017





WELDED, NOT RIVETED. NOW EQUIPPED WITH HANDBRAKE

COVERED FREIGHT CAR GMS 30 DRG

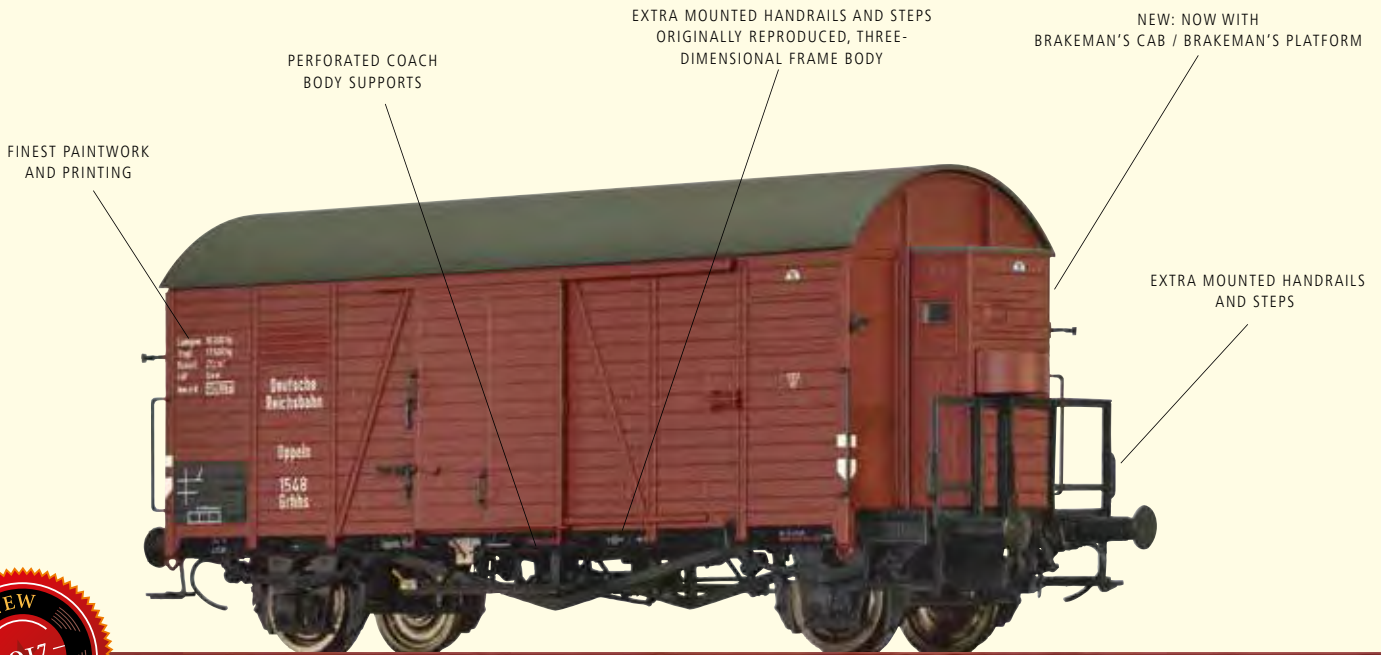

Covered Freight Car Grhhs 30 DRG Road no. Oppeln 1548



The introduction of welding technology from 1933 onwards increasingly made the Deutsche Reichsbahn (DR) switch to joining the components of their wagons by welding instead of riveting. One of the main advantages of welding technology was the weight saving which could then be used for increasing the cargo weight. In order to respond to the demand for higher speeds in part-load traffic as well, the DR developed the "Gs Oppeln", starting in 1936. Due to its wheel base of 6000mm, its maximum permissible speed could be fixed at 90 km/h. In addition to the missing junction plates that were made superfluous by the welding technology, this wagon type mainly differed in the pointed truss frame required due to the long wheel base. The increasing need for goods wagons due to the war led to the mass production of the "Gs Oppeln" from 1938 onwards. As a result, about 28,000 wagons without and 6,100 wagons with handbrake were built in the following years. Many of the wagons were equipped with a steam heating or even an electric

heating system and could therefore be used as part-load wagons in semi-fast and express trains without any problems. After the end of World War II, the wagons were distributed all over Europe and could be found, for example, in the service of the railway administrations of Austria, Czechoslovakia, Poland or Belgium. The reorganisation of the vehicle numbers of the young Deutsche Bundesbahn in the early fifties of the last century led to the change of "Gs Oppeln" into "Gms 30". Some of the wagons even came into the EUROP wagon pool, thus serving on an international basis. With the emergence of the first newly built goods wagons at the end of the fifties, a decision was made against an expensive general overhaul of the wagons. When the UIC numbering system was introduced, the existing wagons were re-numbered into "Glms 200", and some of them survived until 1979.
DELIVERY DATE: 3RD QUARTER 2017

Order no. **47947**

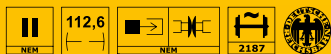

- Wheelsets in toe bearing
- Bogie with three-point support
- Originally reproduced, three-dimensional frame body
- Individually mounted axle box cover
- Brake blocks in wheel plane
- Extra mounted handrails and steps
- Extra mounted axle brake frame
- Extra braking system
- Perforated coach body supports





Order no. **47948**

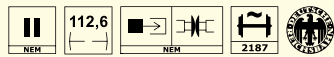

Covered Freight Car Grs DRG
Road no. Oppeln 28 300

DELIVERY DATE: 3RD QUARTER 2017



Order no. **47949**

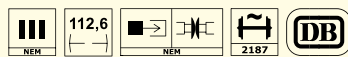

Covered Freight Car Gms 30 DB / EUROP

Road no. 221 847

DELIVERY DATE: 3RD QUARTER 2017



Order no. **47950**



Covered Freight Car Gms 30 DB / EUROP

Road no. 228 096

DELIVERY DATE: 3RD QUARTER 2017





**Covered Freight Car Grs "ALAK" DB
(Brit-US-Zone)**

Road no. 5088

DELIVERY DATE: 3RD QUARTER 2017

Order no. **47956**

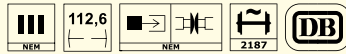

Model: Wheelsets in toe bearing; bogie with three-point support; originally reproduced, three-dimensional frame body; individually mounted axle box cover; brake blocks in wheel plane; extra mounted handrails and steps; extra mounted axle brake frame; extra braking system; perforated coach body supports



Covered Freight Car GkIm 200 DB

Road no. 21 80 145 2 994-3

DELIVERY DATE: 3RD QUARTER 2017

Order no. **47951**

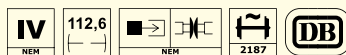

Covered Freight Car Gms ÖBB

Road no. 140 061

DELIVERY DATE: 3RD QUARTER 2017

Order no. **47952**





Order no. **47954**

Covered Freight Car Ms DR
Road no. 07-13-17

DELIVERY DATE: 3RD QUARTER 2017

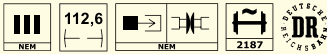

Model: Wheelsets in toe bearing; bogie with three-point support; originally reproduced, three-dimensional frame body; individually mounted axle box cover; brake blocks in wheel plane; extra mounted handrails and steps; extra mounted axle brake frame; extra braking system; perforated coach body supports



Order no. **47955**

Covered Freight Car Hkms DR
Road no. 27 50 222 7914-3

DELIVERY DATE: 3RD QUARTER 2017

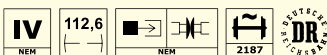

Order no. **47953**





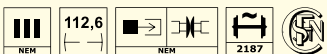

Covered Freight Car Kr SNCF / EUROP
Road no. 7440903

DELIVERY DATE: 3RD QUARTER 2017



Covered Freight Car Grs DRG
Road no. Oppeln 5080









Order no. **47957**      

DELIVERY DATE: 3RD QUARTER 2017

Covered Freight Car Gms 30 "Libella" DB
Road no. 225 466









Order no. **47936**      

AVAILABLE

Covered Freight Car Gmhs 30 DB
Road no. 224 482









Order no. **47958**      

DELIVERY DATE: 3RD QUARTER 2017

Covered Freight Car Gms 30 „Knorr“ DB
Road no. 227 651









Order no. **47966**      

DELIVERY DATE: 3RD QUARTER 2017

Covered Freight Car Gklm²⁰⁰ DB
Road no. 01 80 145 3 885-6









Order no. **47959**      

DELIVERY DATE: 3RD QUARTER 2017

Covered Freight Car Mrhs DR
Road no. 07-56-71









Order no. **47960**      

DELIVERY DATE: 3RD QUARTER 2017

Covered Freight Car Gms "Anker Brot" ÖBB
Road no. 140 333









Order no. **47940**      

AVAILABLE

Covered Freight Car Gms "PEZ" ÖBB
Road no. 140 477



Order no. **47941**      

AVAILABLE



Covered Freight Car Gms ÖBB
Road no. 140 786



Order no. **47862** III 104,6 NEM NEM 2187 ÖBB

DELIVERY DATE: 3RD QUARTER 2017

Covered Freight Car Zr CSD
Road no. 1.35055



Order no. **47942** III 104,6 NEM NEM 2187 ČSD

DELIVERY DATE: 3RD QUARTER 2017

Tank Car K2 "Doornkaat" DRG
Road no. Münster 579 256 [P]



Order no. **47846** II 95,8 NEM NEM 2183

DELIVERY DATE: 3RD QUARTER 2017

Tank Car K2 "Luhns Antuka" DRG
Road no. Wuppertal 544 352 [P]



Order no. **47850** II 95,8 NEM NEM 2183

DELIVERY DATE: 3RD QUARTER 2017

Tank Car K2 "Ovomaltine" SBB
Road no. 32 211 [P]



Order no. **47844** II 95,8 NEM NEM 2183 SBB CFF

AVAILABLE

Covered Freight Car K2 SBB
Road no. 31 117



Order no. **47848** II 95,8 NEM NEM 2183 SBB CFF

DELIVERY DATE: 3RD QUARTER 2017

Covered Freight Car K2 "Maggi" SBB
Road no. 31 112



Order no. **47835** III 95,8 NEM NEM 2183 SBB CFF

AVAILABLE

Covered Freight Car K2 SBB
Road no. 35012



Order no. **47849** III 95,8 NEM NEM 2183 SBB CFF

DELIVERY DATE: 3RD QUARTER 2017



Covered Freight Car Gmmhs 57 DB
Road no. 216 021



Tariff conditions on the one hand and technical conditions on the other resulted in all State railway administrations developing box cars with almost identical dimensions and payloads. These cars had a 4.5 m wheelbase, a length over buffers of 9.3 m for unbraked cars, a payload of 15 t, later 17 t and a floor area of approx. 21 square metres. This type of freight construction became the most important and most built box car; it originally had the type identifier Gm.

The most common of these State railway cars, which numbered 47,533, were built according to the Prussian style sheet IId8. After the founding of the Deutscher Staatsbahn Wagen Verband (German state railway car federation) DWV in 1909, the federation car construction type A2 was developed from this.

From 1911 a phenomenal total of 121,770 units were built, making it the most heavily produced box car. It dominated the image of the German goods trains until the early days of the third era. These cars were scattered all over Europe by two world wars, there were no European railway administrations where this type of car was not used at least temporarily.

DELIVERY DATE: 1ST QUARTER 2017

Order no. **47259**



- Metal wheels
- Extra signal holders
- Separately mounted axle box cover
- Finest paintwork and printing
- Close coupling
- Wheelsets in toe bearing
- Extra mounted steps and handrails in low-material thickness
- Multi-part brake system with brake shoes in wheel plane
- Undercarriage with brake systems

Covered Freight Car Hbrs-57 DB
Road no. 217 087



Order no. **47260**

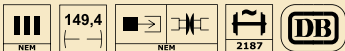

DELIVERY DATE: 1ST QUARTER 2017

Covered Freight Car Gbs 253 DB
Road no. 21 80 155 5 584-8



Order no. **47261**

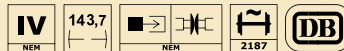



DELIVERY DATE: 1ST QUARTER 2017



Covered Freight Car Gbs 253 DB
Road no. 21 80 155 5 219-1

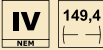



Order no. **47262**   

DELIVERY DATE: 1ST QUARTER 2017

Covered Freight Car Gos 253 DB AG
Road no. 21 80 141 3 544-4

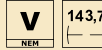
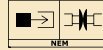



Order no. **47263**   

DELIVERY DATE: 1ST QUARTER 2017

Covered Freight Car Gbs 245 DB, set of 2
Road no. 21 80 152 4 169-6/22 80 152 5 820-3

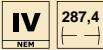

Order no. **47265**   

DELIVERY DATE: 3RD QUARTER 2017

Covered Freight Car Gos DR
Road no. 21 50 140 1027-3





Order no. **47266**   

DELIVERY DATE: 3RD QUARTER 2017

Covered Freight Car Gos-uv 253 "Peugeot Talbot" DB
Road no. 21 80 141 4 413-1

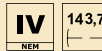
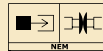



Order no. **47267**   

DELIVERY DATE: 3RD QUARTER 2017

Covered Freight Car Gltr 23 "Goggo Motorroller" DB
Road no. 195 469

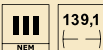



Order no. **48712**   

AVAILABLE

Covered Freight Car Gltrhs 23 "MAN" DB
Road no. 195 058

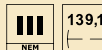
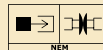

Order no. **48718**   

DELIVERY DATE: 3RD QUARTER 2017



Container Car BTmms58 "Von Haus zu Haus" DB, with Dikr 602 „Von Haus zu Haus“
 Betriebs-Nr. 020 031



REPLICA OF THE ORIGINAL: SLG. BRAWA

In 1958, the SEAG company built two prototypes of the BTmms 58 derived from the BTms 55, which was designed for four "pa" containers. The cars, one built of light metal and the other of ST 52 steel, could now be loaded with five "pa" containers. This allowed the specific cargo weight to be increased, which in turn allowed the carrier to pay more advantageous rates for freight. The prototype made of steel proved its worth and was further developed to prepare it for volume production, which began in 1960. Over the next six years, a total of 2100 cars of the BTmms 58 class were produced.

To simplify dispatching and loading, one end each car had a transition platform located above the buffers or a hand-brake platform in front of the vehicle frame.

DB simultaneously exchanged the 35-tonne buffers for heavy duty 59-tonne buffers which were also used from the outset on cars constructed from 1964 onwards. With their V2A containers having a capacity of 5 m3, the medium tank wagons of the types Dikr 602 and 603 were solely designed for the transport of food such as edible oils, juices, and wine. However, also sea water and fuel oils have been documented as cargo for these container types.
 DELIVERY DATE: 4TH QUARTER 2017

Order no. **49123**



- With 5 containers (Ddikr603)
- Model with transition platform or hand-brake platform
- Container removable
- Brake shoes in wheel plane
- Three-point support
- Separately mounted axle brake rod
- Extra mounted steps and brake system
- Finest paintwork and printing
- NEM-standard close coupling
- Originally reproduced, three-dimensional frame body
- Metal frame

Container Car Lbs 589 DB, with Ddikr603 "Texaco"
 Road no. 21 80 411 3 120-0

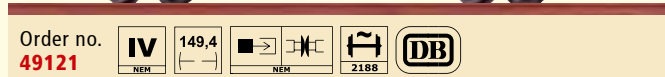

DELIVERY DATE: 4TH QUARTER 2017

Container Car Lbs 589 DB, with Ddikr603 "DEA"
 Road no. 21 80 411 3 187-9



DELIVERY DATE: 4TH QUARTER 2017



Container Car Lbs-58 BTmms DB, with Eoskrt022 "Von Haus zu Haus"
 Betriebs-Nr. 020 207



REPLICA OF THE ORIGINAL: SLG. S. CARSTENS

Open "pa" containers were generally used for bulk goods such as sand and coal. Around 5,300 units of the Eoskrt 022 "pa" container were built between 1960 and 1973, thus making it one of the most widespread types. In particular the small urban fuel traders quickly recognised the advantages of the open "pa" containers. Both the cargo handling and the portioning were made significantly easier, and it was possible to cleanly separate different types of coal within a single delivery. In addition to bulk goods that were not sensitive to moisture, the transported goods included bricks, roof tiles, construction and mining timber as well as bulky general cargo that could then be covered with tarpaulins.

DELIVERY DATE: 4TH QUARTER 2017

Order no. **49125**



- With 5 containers (Eoskrt 022)
- Model with transition platform or hand-brake platform
- Container removable
- Brake shoes in wheel plane
- Three-point support
- Separately mounted axle brake rod
- Extra mounted steps and brake system
- Finest paintwork and printing
- NEM-standard close coupling
- Originally reproduced, three-dimensional frame body
- Metal frame

Container Car Lbs 589 DB, with Eoskrt022 "Von Haus zu Haus"
 Road no. 21 80 411 3 266-1



REPLICA OF THE ORIGINAL: ROLF MICHAEL HAUGG

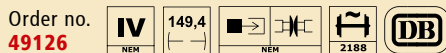

DELIVERY DATE: 4TH QUARTER 2017

Container Car Lbms 589 DB, with Eoskrt022 "Von Haus zu Haus"
 Road no. 21 80 411 2 248-0



REPLICA OF THE ORIGINAL: SLG. S. CARSTENS

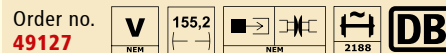





DELIVERY DATE: 4TH QUARTER 2017



Container Car Lbs 58 DB, with Ddokr 612 „Erstes Kulmbacher Actienbier“
Road no. 020 024







Order no. **49114**  149,4    

DELIVERY DATE: 1ST QUARTER 2017

Container Car BTmms 58 DB,
with Ddokr 612 "Dortmunder Stifts-Bier"
Road no. 020 245







Order no. **49116**  149,4    

DELIVERY DATE: 1ST QUARTER 2017

Container Car Lbs-58 DB, with Ekrt 212 "Bahlsen"
Road no. 020 144



Order no. **49124**  149,4    

DELIVERY DATE: 4TH QUARTER 2017

Open Medium Container Type Eoskrt 022 "Von Haus zu Haus",
individual, suitable for Container Car BTmms 58





Order no. **94703**  

DELIVERY DATE: 4TH QUARTER 2017

Open Medium Container Type Eoskrt 022 "Von Haus zu Haus",
individual, suitable for Container Car Lbs-58



Order no. **94704**  

DELIVERY DATE: 4TH QUARTER 2017



Tank Car Zas „Fazeni“ GATX
 Road no. 33 80 7956 518-4



Order no. **48762** VI 187,5 NEM GATX

DELIVERY DATE: 2ND QUARTER 2017

Tank Car Zas "Wassertransportwagen" SBB
 Road no. 98 85 93-90 001-7



Order no. **48763** VI 187,5 NEM SBB

DELIVERY DATE: 2ND QUARTER 2017

Tank Car Zas "Wassertransportwagen" SBB
 Road no. 98 85 93-90 002-5



Order no. **48764** VI 187,5 NEM SBB

DELIVERY DATE: 2ND QUARTER 2017

Tank Car Uahs-w "Buna" DR
 Road no. 31 50 727 0 243-6



Order no. **48766** IV 187,5 NEM DR



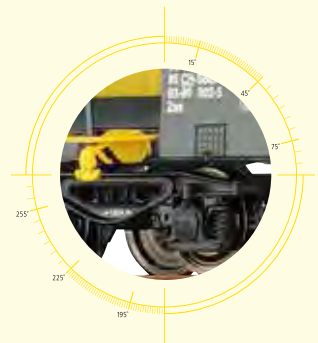



DELIVERY DATE: 2ND QUARTER 2017





Tank Car ZZ [P] „VTG“ DB
Road no. 591 453 [P]









Order no. **48938**       

DELIVERY DATE: 2ND QUARTER 2017

Tank Car ZZ [P] „EVA“ DB
Road no. 539 314 [P]









Order no. **48939**       

DELIVERY DATE: 2ND QUARTER 2017

Tank Car ZZ [P] „Dynamit Nobel“ DB
Road no. 546 098 [P]









Order no. **48914**       

DELIVERY DATE: 2ND QUARTER 2017

Tank Car ZZ "Leuna" DR
Road no. 51-74-83 P



Order no. **48927**       

DELIVERY DATE: 2ND QUARTER 2017





Tank Car ZZr DR
Road no. 51-71-36 [P]



Order no. **48932** III 142,5 NEM 2187 DR

DELIVERY DATE: 2ND QUARTER 2017

Tank Car ZZ DR
Road no. 21 50 075 0113-7



Order no. **48933** IV 142,5 NEM 2187 DR

DELIVERY DATE: 2ND QUARTER 2017

Tank Car Ra CSD
Road no. 558044 [P]



Order no. **48928** III 142,5 NEM 2187 ČSD

DELIVERY DATE: 2ND QUARTER 2017

Covered Freight Car GGhrsz DR
Road no. 15-51-71



Order no. **48391** III 189,6 NEM 2187 DR

DELIVERY DATE: 3RD QUARTER 2017





WE MAKE SOME OF OUR MODELS SHOW THEIR AGE...

- Limited Edition -

This is another example of our love of detail. Fans of raw realism can enjoy selected BRAWA models with natural-looking signs of ageing. However, they come in strictly limited editions, with each model individually distressed professionally by hand. The airbrushed rust and dirt look incredibly real – for even more satisfaction with a model railway „drawn from life“.

Open Freight Car Om 21 SAAR / EUROP
Road no. 2825



Order no. **48428** 104,6 **SAAR**

AVAILABLE

Open Freight Car Om 21 SAAR / EUROP
Road no. 2825



Order no. **48431** 104,6 **SAAR**

DELIVERY DATE: 2ND QUARTER 2017

Covered Freight Car Kmmks 51 DB
Road no. 360 376



Order no. **48617** 115,9

AVAILABLE

Covered Freight Car Kmmks 51 DB
Road no. 360 376



Order no. **48622** 115,9

DELIVERY DATE: 2ND QUARTER 2017

Covered Freight Car Ts 851 DB
Road no. 21 80 570 1 819-2



Order no. **48620** 121,6

AVAILABLE

Covered Freight Car Ts 851 DB
Road no. 21 80 570 1 819-2



Order no. **48623** 121,6

DELIVERY DATE: 2ND QUARTER 2017





Coal Cars OOtz 23 DB, set of 10

(in the trade stores als separately available)

Road no. 610 097 / 610 102 / 610 111 / 610 126

/ 610 133 / 610 140 / 610 144 / 610 151 / 610 158 / 610 166



Order no.
45908



1147



2187



Deutsche Bundesbahn

DELIVERY DATE: 1ST QUARTER 2017

Coal Cars OOtz 23 DB, set of 10

(in the trade stores als separately available)

Road no. 610 097 / 610 102 / 610 111 / 610 126

/ 610 133 / 610 140 / 610 144 / 610 151 / 610 158 / 610 166



Order no.
45909



1147



2187



Deutsche Bundesbahn

DELIVERY DATE: 2ND QUARTER 2017



MORE ILLUMINATION FOR YOUR MODEL RAILWAY

Bulbholder with LED



LAYOUT VERSION



Order no. **94700**

- New mould wide angle of reflection (160°), for perfect illumination of buildings
 - Ø 1,5 cm, round
 - Light: warm white
 - Low power input
 - Virtually unlimited service life due to LED technology
 - With 2 cables
 - With 2 mounting lug
 - Individual, packed in bag
- DELIVERY DATE: AUTUMN 2017

Wooden Box "Fortschritt" DR



Order no. **94701**

- For loading of BRAWA H0 Freight Cars, e. g. Rail Car SSIma, Flat Car Samm, Stake Car Rr, etc.
 - Dimensions: 72 x 30 x 27 mm (width x height x depth)
- DELIVERY DATE: 2ND QUARTER 2017

Marble Block



Order no. **94702**

- For loading of BRAWA H0 Freight Cars, e. g. Rail Car SSIma, Flat Car Samm, Stake Car Rr, etc.
 - Dimensions: 40 x 23 x 20 mm (width x height x depth)
- DELIVERY DATE: 2ND QUARTER 2017

H0



SMALL GAUGE. BIG DIESEL DETAILS

**NEU
NEW**
TECHNICALLY REVISED:
NOW WITH BRAWA-SOUND,
REAR LIGHTS,
NEXT18 INTERFACE

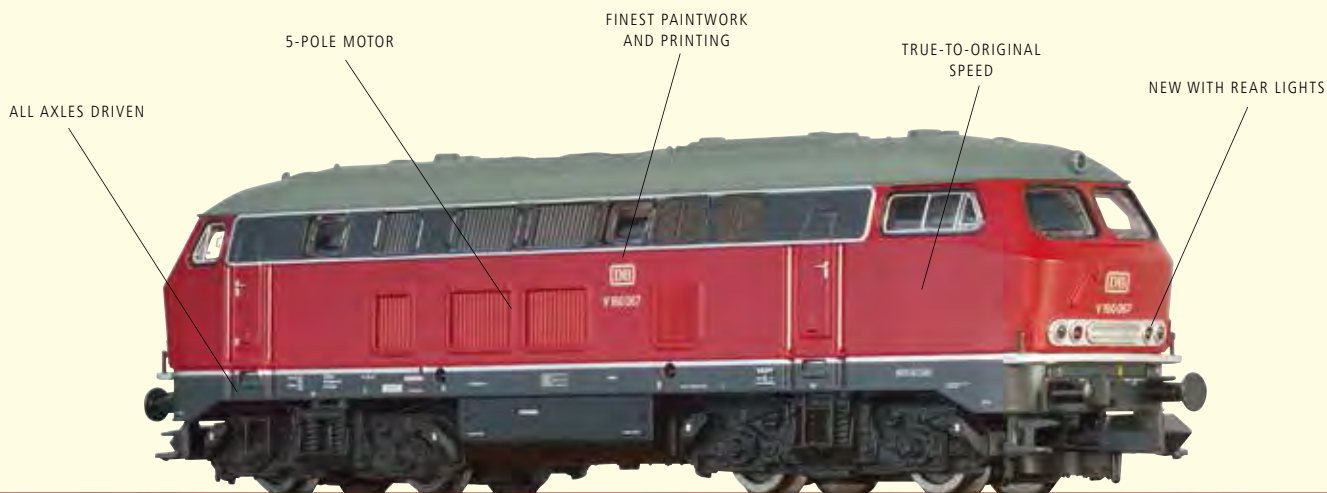

Diesel Locomotive V160 DB Road no. V160 067



Up to the mid-fifties, motor engineering did not make it possible to build a main-line diesel locomotive with only one propulsion system and sufficient power. Consequently, the V200 and V200.1 series were built with two propulsion systems in order to meet their performance requirements. However, the manufacturers worked at full stretch on stronger motors, and already at the end of the decade, a power of 1400kW from one propulsion system was no illusion anymore. Already in 1956, the Krupp company began to develop a medium-duty main-line diesel locomotive with one motor, a steam heating system, and a Vmax of 120 km/h. In 1960, Krupp and Henschel delivered a total of ten pilot-production machines nine of which received the nickname "Lollo" due to their exterior, inspired by Gina Lollobrigida. The tenth locomotive had already a prosaic, much more angular shape and could be produced considerably cheaper and was therefore adopted for the series production. The machines stood the test in goods train service and passenger service and, after extensive testing, they were produced in series from 1964 to 1968. The companies Krupp, Henschel,

KHD, Krauss-Maffei, and MaK supplied 214 series locomotives in total. They were used in the entire German Federal Territory, more and more in goods traffic following the delivery of the BR 218 locomotive and the increasing use of the electrical train heating. After the prototype locomotives had been withdrawn by 1984, the removal of the series locomotives started in 1993. More and more railcars were used in passenger service which led to a further elimination of diesel locomotives. Goods traffic declined, and the 232 series came from the East-German Deutsche Reichsbahn (DR). One locomotive of this series often replaced a double traction. By 2004, all 216-series locomotives had been decommissioned; however, many locomotives were taken over by private railway enterprises at home and abroad. In the meantime, some of the locomotives have even returned and are in use in the approximated original state. The DB Museum received the 216 003 locomotive in Lübeck and the 216 067 locomotive in Koblenz.
DELIVERY DATE: 4TH QUARTER 2017

Order no. 61206	Order no. 61207		

MORE INFORMATION ABOUT THE DIESEL LOCOMOTIVES BR 216 AT:

WWW.BRAWA.DE

- New with Next18 interface
- Rear signals
- Illuminated driver's cab
- Sound

- True-to-original speed
- 5-pole motor
- All axles driven
- Standard shaft to NEM 355

- Finest paintwork and printing
- Front light changes according to direction of travel
- Improved traction



PICTURE SHOWS HO-MODEL



Order no.
61208

Order no.
61209

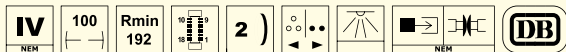

Diesel Locomotive BR 216 DB

Road no. 216 118-0

When compiling the standard design programme of the Deutsche Bundesbahn, a mainline diesel locomotive with an output of 1500-1600 HP had already been considered. The engine and drive system of the resulting V160 is closely based on the locomotives of V100. The locomotives of Class 216 were used in nearly all railway divisions of the Deutsche Bundesbahn. They were used for both passenger and freight transport, where they provided good service. The 216 118-0 was based at the Oldenburg depot of the Münster railway division at the beginning of the 1970s and was used there mostly for passenger trains.

DELIVERY DATE: 4TH QUARTER 2017

PICTURE SHOWS HO-MODEL



Order no.
61210

Order no.
61211

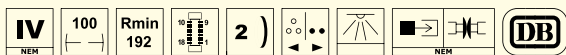

Diesel Locomotive BR 216 DB

Road no. 216 224-6

After numerous debates, the Deutsche Bundesbahn introduced a new colour scheme to underline its modernity. Whereas there were very innovative ideas among the proposals, underlining the elegance of many railway vehicles, the result was rather modest in the opinion of many experts. „Ocean bluebeige“, as the new creation was called, was the most unpopular colour design among railway enthusiasts and only became a popular subject of photographs towards its foreseeable end.

DELIVERY DATE: 4TH QUARTER 2017



Order no.
61212

Order no.
61213

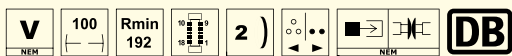

Diesel Locomotive BR 216 DB Cargo

Road no. 216 139-6

The 216 locomotive series had already reached the end of its useful life in the 90ies. After the split-up of locomotives and employees over the business areas, the 216 was operated by DB Cargo, as the freight traffic division was called at that time. As the management - unlike in former years - pinned their hopes to a rapid implementation of the "corporate identity", many locomotives of all series were repainted even a few years prior to their decommissioning.

DELIVERY DATE: 4TH QUARTER 2017



Order no.
61214

Order no.
61215

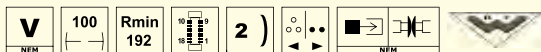

Diesel Locomotive BR 216 Wiebe

Road no. 216 122-2

DB AG has already started decommissioning the V160/216 locomotives. The former 216 122-2 locomotive, on the other hand, is being used throughout Germany by Wiebe Gleisbau Maschinen GmbH.

DELIVERY DATE: 4TH QUARTER 2017





Diesel Railcar VT171 DR, with panorama windows

Road no. 171 012-8 / 171 812-1

A local traffic legend - known as the Blutblase (blood blister), Ferkeltaxe (piglet taxi) or simply Schienenbus (rail bus). In 1957, VEB Waggonbau Bautzen produced the first prototype of what was to become the universally familiar rail bus. Over the course of the 1960s, it evolved into the undisputed number 1 on side lines of the DR. Thousands commuted daily between their homes and workplaces – using the "Ferkeltaxe". In 1959, Waggonbau Bautzen unveiled a second test vehicle. Now the rail bus featured a diesel engine that was twice as powerful as the first prototype, at 180 hp. The VT 2.09.1, which was implemented in 1965/69, was distinguished above all by the multiple control system of the basic model. Now it was possible to drive two engines from one driver's cab.

DELIVERY DATE: 2ND QUARTER 2017

Diesel Railcar VT172 DR

Road no. 172 112-5 / 172 712-2

DELIVERY DATE: 2ND QUARTER 2017



Order no.
64304

Order no.
64305

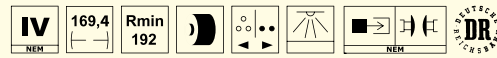

Model: New with interface (digital version with decoder, analog version with soldering points; free view into the passenger compartment; true-to-original lighting; three-point support; improved power take-up via wheel loop; new conducting coupling; light between wagon units can be switched off (analog and digital); new body with panorama window; interior lighting; with



Order no.
64306

Order no.
64307

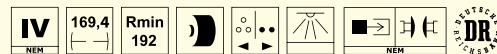











PICTURE SHOWS HO-MODEL



**Diesel Locomotive BR 232
Wismut AG**
Road no. V300 002

For coupling sand trains for the purpose of restoring the uranium-ore mines in the Ronneburg region, the Wismut AG was still using their V200 which had been directly delivered there in the 70ies. With the increasing age and the removal from service at the DBAG, economic maintenance of this series was no longer ensured. Therefore, three machines of this series were taken over and re-motorised in Cottbus. They have the fleet number V300 001 - 003 and are painted in mint-green/grey. DELIVERY DATE: 2ND QUARTER 2017

Order no. **61020** Order no. **61021**  









Model: With sound, interface and front light changing red/white; interface accessible with a cover; 5-pole motor; all axles driven; standard shaft to NEM 355; front light changes according to direction of travel



**Diesel Locomotive BR 232
DB Cargo AG**
Road no. 232 347-5

DELIVERY DATE: 2ND QUARTER 2017

Order no. **61022** Order no. **61023**  



interior fittings; new engine and new transmission; digital versions: decoder and loudspeaker in the engine car; with taillights and headlights; trailer true-to-original only with red taillights



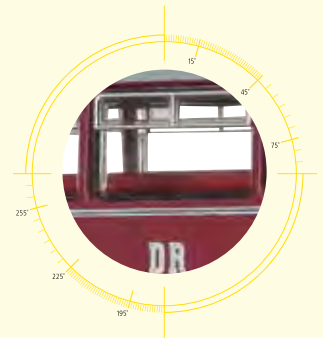
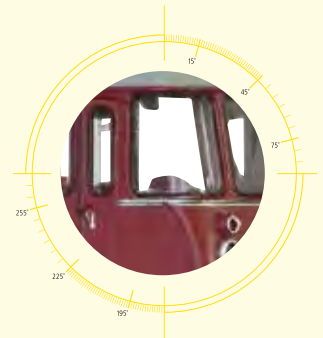

TWO REASONS TO BE EXCITED: NEW ORIGINALS ON THE HORIZON

For many years now, double-decker trains have successfully formed the backbone of regional traffic. Doubledecker trains are the ideal solution, especially on routes with low platform lengths and a high volume of passengers. The tried-and-tested single-wagon concept of the TWINDEXX Vario double-decker fleet is now being supplemented with an electrical railcar. Until today, DB Regio AG has ordered more than 50 of these Railcars in different configurations, as 4- 5- and 6-unit train versions. Each of these Railcars consist of two Motor cars and two to four middle cars. In Bavaria, the Main-Spessart-Express will operate in total twelve of these Railcars in the 4-Unit

version, all of them are going to be based in Würzburg. This railcar can be combined with additional middle wagons depending upon the application and desired capacity. The central buffer coupling enables operation with double traction and, as a result, the implementation of a wing-train concept. The trains are comfortably equipped with generous seat spacing and plenty of storage space. Furthermore, the double-decker individual wagons permit the extension and shortening of the block train and, consequently, an adjustment to fluctuating demand or future development. As a result, they can be utilised for the most diverse of operational applications in both regional traffic.

Base Version N

TWINDEXX Vario® Double-Deck Train DB Regio, 3-unit
Road no. follow
(Content: 2 Railcars 2nd class, 1 Middle Wagon 1st / 2nd class)

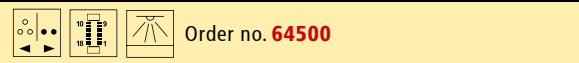

DELIVERY DATE: 4TH QUARTER 2017

Version digital with sound

TWINDEXX Vario® Double-Deck Train DB Regio, 3-unit
Road no. follow
(Content: 2 Railcars 2nd class, 1 Middle Wagon 1st / 2nd class)

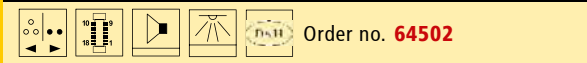

DELIVERY DATE: 4TH QUARTER 2017

TWINDEXX Vario® Double-Deck Middle Wagon DB Regio
Road no. follow
(Addition to Double-Deck Train 64500)



DELIVERY DATE: 4TH QUARTER 2017

TWINDEXX Vario® Double-Deck Middle DB Regio
Road no. follow
(Addition to Double-Deck Train 64502)

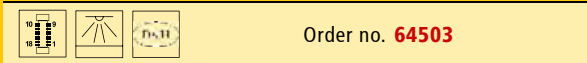

DELIVERY DATE: 4TH QUARTER 2017

Advice: Please note that it is not possible to retrospectively convert the interior lighting (order no. 64500 and 64501). Further information will be provided on the BRAWA website later this year.



REPLICA OF THE ORIGINAL: RAINER ALBRECHT

* 1:160

INTERCITY 2 - TWINDEXX VARIO® DOUBLE-DECK COACHES FOR DB FERNVERKEHR AG

For many years now, double-decker trains have successfully formed the backbone of regional traffic. Doubledecker trains are the ideal solution, especially on routes with low platform lengths and a high volume of passengers. The tried-and-tested single-wagon concept of the TWINDEXX Vario double-decker fleet is now being supplemented with an electrical railcar.

Bombardier Transportation will supply 16 Bombardier TWINDEXX Vario railcars with regional train equipment to Deutsche Bahn AG. The new four-part railcars from the „Do 2010“ generation consist of 2 railcars and 2 middle wagons respectively. With the newly-developed driven TWINDEXX Vario railcar, it is now possible to utilise the trains as pure double-decker multiple unit trains. As a result, it is also possible to use this vehicle as an electric multiple unit train alongside

the classic push-pull operation with an electric or diesel locomotive. This railcar can be combined with middle wagons and control cars depending upon the application and desired capacity. The central buffer coupling enables operation with double traction and, as a result, the implementation of a wing-train concept. The trains with a combined upper and lower entrance are comfortably equipped with generous seat spacing and plenty of storage space. Furthermore, the double-decker individual wagons permit the extension and shortening of the block train and, consequently, an adjustment to fluctuating demand or future development. As a result, they can be utilised for the most diverse of operational applications in both regional and longdistance traffic.

TWINDEXX VARIO® IC 2-Double-Deck Coaches, 3-unit (Content: 1 Control Car, 2 Middle Wagons 2nd Class), with interior lighting

Road no. 50 80 86-81 873-1 / 50 80 26-81 402-2 / 50 80 26-81 469-1



Order no. **64507**



DELIVERY DATE: 4TH QUARTER 2017

TWINDEXX VARIO® IC 2-Double-Deck Middle Wagon 1st Class (Addition to 3-unit coaches 64507), with interior lighting

Road no. 50 80 16-81 171-5



TWINDEXX VARIO® IC 2-Double-Deck Middle Wagon 2nd Class (Addition to 3-unit coaches 64507), with interior lighting

Road no. 50 80 26-81 468-3



Order no. **64508**



DELIVERY DATE: 4TH QUARTER 2017



Order no. **64509**



DELIVERY DATE: 4TH QUARTER 2017

- Exactly scale 1:160
- True-to-original length over buffer
- Structure made of high-quality, impact-resistant plastic
- Metal bottom plate
- Printed window frames
- In-plane assembled windows
- Illuminated destination indicator (digital)
- Lighting with warm white LEDs
- Long-distance headlights (digital)

- True-to-scale details
- Perfectly replicated three-dimensional front
- Finely engraved details
- Finest paintwork and printing
- Illuminated driver's cab
- With interior fittings, incl. driver's cab
- NEM-standard close coupling
- Lights change white/red, in the direction of travel
- For digitizing the coaches: function decoder order no. 99821



Covered Freight Car Gos-UV 253 "Peugeot Talbot" DB
Road no. 21 80 141 4 418-8



PICTURE SHOWS HO MODEL

Tariff conditions on the one hand and technical conditions on the other resulted in all State railway administrations developing box cars with almost identical dimensions and payloads. These cars had a 4.5 m wheelbase, a length over buffers of 9.3 m for unbraked cars, a payload of 15 t, later 17 t and a floor area of approx. 21 square metres. This type of freight construction became the most important and most built box car; it originally had the type identifier Gm. The most common of these State railway cars, which numbered 47,533, were built according to the Prussian style sheet IId8. After the founding of the Deutscher Staatsbahn Wagen Verband (German state railway car federation) DWV in 1909, the federation car construction type A2 was developed from this. From 1911 a phenomenal total of 121,770 units were built, making it the most heavily produced box car. It dominated the image of the German goods trains until the early days of the third era. These cars were scattered all over Europe

by two world wars, there were no European railway administrations where this type of car was not used at least temporarily. From 1938 the cars were reinforced in order to absorb the loads due to installation of compressed air brakes and the increased speeds. Diagonal struts were welded into the end panels, the front posts were partly rotated by 90 degrees. The last cars converted in this way were in service until the 1970s; afterwards they migrated into track repair service. Some of these still exist today, partly in museum railways.

DELIVERY DATE: 4TH QUARTER 2017

Order no. **67802**

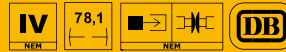

- Finely engraved board joints and ventilators
- Finest paintwork and printing
- NEM-standard short-coupling

- True-to-original replica of the brake unit on the car bottom
- Metal wheels

- True-to-original frame body

Refrigerator Car for bananas Tnoms 59 50 DB
Road no. 328 957



PICTURE SHOWS HO MODEL

Order no. **67804**

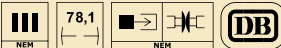

DELIVERY DATE: 4TH QUARTER 2017

Covered Freight Car Glmhs 50 DB
Road no. 250 195



PICTURE SHOWS HO MODEL

Order no. **67806**



DELIVERY DATE: 4TH QUARTER 2017



Refrigerator Car for bananas Ibbbs
 Transthermos GmbH / DB
 Road no. 01 80 083 4 251-1



Order no. **67800**

DELIVERY DATE: 4TH QUARTER 2017

Covered Freight Car Gos 245 DB AG
 Road no. 21 80 140 6 417-2



Order no. **67801**

DELIVERY DATE: 4TH QUARTER 2017

Covered Freight Car Glmhs 50 DB
 Road no. 203 050 / 206 023 / 203 665



Order no. **67803**

DELIVERY DATE: 4TH QUARTER 2017

Covered Freight Car Gbs 245 DB
 Road no. 11 21 80 152 5 661-1 / 21 80 152 5 154-8 / 21 80 152 7 356-7



Order no. **67805**

DELIVERY DATE: 4TH QUARTER 2017



Tank Car Uahs-w "Buna" DR
Road no. 31 50 727 0 243-6







Order no. **67249**     

DELIVERY DATE: 2ND QUARTER 2017

Tank Car Zas "Fazeni" GATX
Road no. 33 80 7956 518-4







Order no. **67245**     

DELIVERY DATE: 2ND QUARTER 2017

Tank Car Zas "Wassertransportwagen" SBB
Road no. 98 85 93-90 001-7







Order no. **67246**     

DELIVERY DATE: 2ND QUARTER 2017

Tank Car Zas "Wassertransportwagen" SBB
Road no. 98 85 93-90 002-5







Order no. **67247**     

DELIVERY DATE: 2ND QUARTER 2017

Refrigerator Car UIC Standard 1 "Interfrigo" DB
Road no. 524 053 [P]







Order no. **67112**     

AVAILABLE

Refrigerator Car UIC Standard 1 Ibeqs "Interfrigo" FS
Road no. 01 83 803 5 625-5 [P]



Order no. **67117**     

AVAILABLE



Tank Car ZZ [P] "Gasolin" DB
Road no. 565 228 [P]



Order no. **67072** III 65,5 DB

DELIVERY DATE: 2ND QUARTER 2017

Tank Car ZZ [P] "VTG" DB
Road no. 20 80 077 3 215-8 [P]



Order no. **67073** IV 65,5 DB

DELIVERY DATE: 2ND QUARTER 2017

Covered Freight Car Gms 35 "Darmol" DB
Road no. 232 040



Order no. **67312** III 58,1 DB

AVAILABLE

Flat Car Samm-u 453 DB AG
Road no. 31-80 482 0 026-1



Order no. **67012** V 58,1 DB

DELIVERY DATE: 3RD QUARTER 2017

Flat Cars Samm DR, set of 3
Road no. 31-50-486 7317-4 / 31-50-482 0388-1 / 31-50-486 7578-1



Order no. **67011** IV 297 DR

DELIVERY DATE: 3RD QUARTER 2017



**AUTOMATICALLY RECEIVE
NEWS FROM BRAWA**

ALWAYS UP-TO-DATE

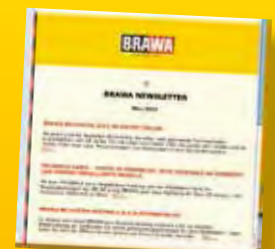

Which new models are in the starting blocks? Are technical innovations in the pipeline? Where can I experience BRAWA live in the near future? If you wish, you can have the answers to these questions and many more sent to you regularly and free to your door. Simply subscribe to the free BRAWA newsletter at www.brawa.de and you'll always know what's currently happening. www.brawa.de/newsletter





FUEL FOR TRAILERS. CRAFTED WITH A WONDERFUL ATTENTION TO DETAIL

TANK CAR UERDINGEN DRG



PICTURE SHOWS H0-MODEL

Tank Car ZZ [P] "Wirtschaftliche Forschungsgesellschaft m.b.H. Berlin" DRB Road no. 920 152 [P]



In 1939/40, the Köln-Deutz (Cologne-Deutz) and Uerdingen wagon factories each constructed a quadruple axle tank wagons in a lightweight design. Directly related to this, Westwaggon also manufactured the prototype of the tub-style tender, with which the war locomotives belonging to the BR 42 and 52 were coupled. The development was primarily driven by the military since it was necessary to transport enormous amounts of crude oil and fuels for replenishment purposes. As was the case with all war designs, the lightweight design was fully utilised in order to maximise the potential of the available steel quota. However, it soon became apparent that this was done to the detriment of the durability. At this point, both manufacturers were developing wagons with self-supporting tanks. Whilst Deutz left it at puffer beams, the Uerdinger design also boasted solebars manufactured from bevelled profiles that were intended to contribute in absorbing longitudinal compression forces. The main data of both versions was identical: The length over buffers amounted to 12.40 m, the bogie pivot distance amounted to 6.60 m and the tank contained 63 m³. As a result of the compact design, this amount lead to axle and metre load problems, meaning that it was not possible to completely fill the tank on all routes. Pressed sheet metal bogies with a 2.00 m

wheel base were used as the running gear. The wagons that were built up until 1945 were deployed at "Wifo" (scientific research community) and oil associations in order to supply the German Armed Forces. After 1945, various European companies reproduced the wagons in a more advanced form, as did Tatra in Prague in 1946. In 1955, SEAG supplied almost 500 units of the wagons developed from the Uerdingen design to the United States Transportation Corps (USTC). Due to the war, many wagons were lost or remained in the territories of other European state railways. The wagons located in the catchment area of the western occupation zones made their way to VTG, which emerged from the former "Wifo" in 1951. In addition to this, mineral oil companies deployed further wagons in the form of P wagons and emerged as main tenants of the VTG wagons. The wagons that stayed with DR remained in the inventory of the state railway and were only leased out on a long-term basis, primarily to PCK Schwedt/ Oder in this case. The last wagons were only removed from the inventory in the 1990s and were being used as maintenance cars or station wagons. In this guise, they could still be regularly seen after the turn of the millennium.

DELIVERY DATE: 4TH QUARTER 2017

Order no. **67700**



- Brake shoes in wheel plane
- Separately mounted buffers
- Finest paintwork and printing

- Freestanding placards
- NEM-standard short-coupling
- Metal wheels

- Originally reproduced, three-dimensional frame body



Tank Car ZZ [P] "VTG" DB
Road no. 596 778 [P]



PICTURE SHOWS HO-MODEL



Order no. **67701** III 77,5 DB

DELIVERY DATE: 4TH QUARTER 2017

Tank Car ZZ [P] "BP" DB
Road no. 581 672 [P]



PICTURE SHOWS HO-MODEL



Order no. **67708** III 77,5 DB

DELIVERY DATE: 4TH QUARTER 2017

Tank Car ZZ [P] "Esso" DB
Road no. 21 80 005 1 287-9



PICTURE SHOWS HO-MODEL



Order no. **67702** IV 77,5 DB

DELIVERY DATE: 4TH QUARTER 2017

Tank Car ZZ [P] "IVG" DB
Road no. 5 533 023 [P]



PICTURE SHOWS HO-MODEL



Order no. **67703** IV 77,5 DB

DELIVERY DATE: 4TH QUARTER 2017

Tank Car ZZr "VEB Leunawerke" DR
Road no. 51-75-10



PICTURE SHOWS HO-MODEL



Order no. **67704** III 77,5 DR

DELIVERY DATE: 4TH QUARTER 2017

Tank Car ZZw
"VEB Petrolchemisches Kombinat Schwedt" DR
Road no. 31 50 725 1261-1



PICTURE SHOWS HO-MODEL



Order no. **67705** IV 77,5 DR

DELIVERY DATE: 4TH QUARTER 2017

Tank Car ZZ [P] "OMV" ÖBB
Road no. 537 466 P



PICTURE SHOWS HO-MODEL



Order no. **67706** III 77,5 ÖBB

DELIVERY DATE: 4TH QUARTER 2017

Tank Car ZZ [P] "OMV" ÖBB
Road no. 537 419 P



PICTURE SHOWS HO-MODEL



Order no. **67707** III 77,5 ÖBB





DELIVERY DATE: 4TH QUARTER 2017

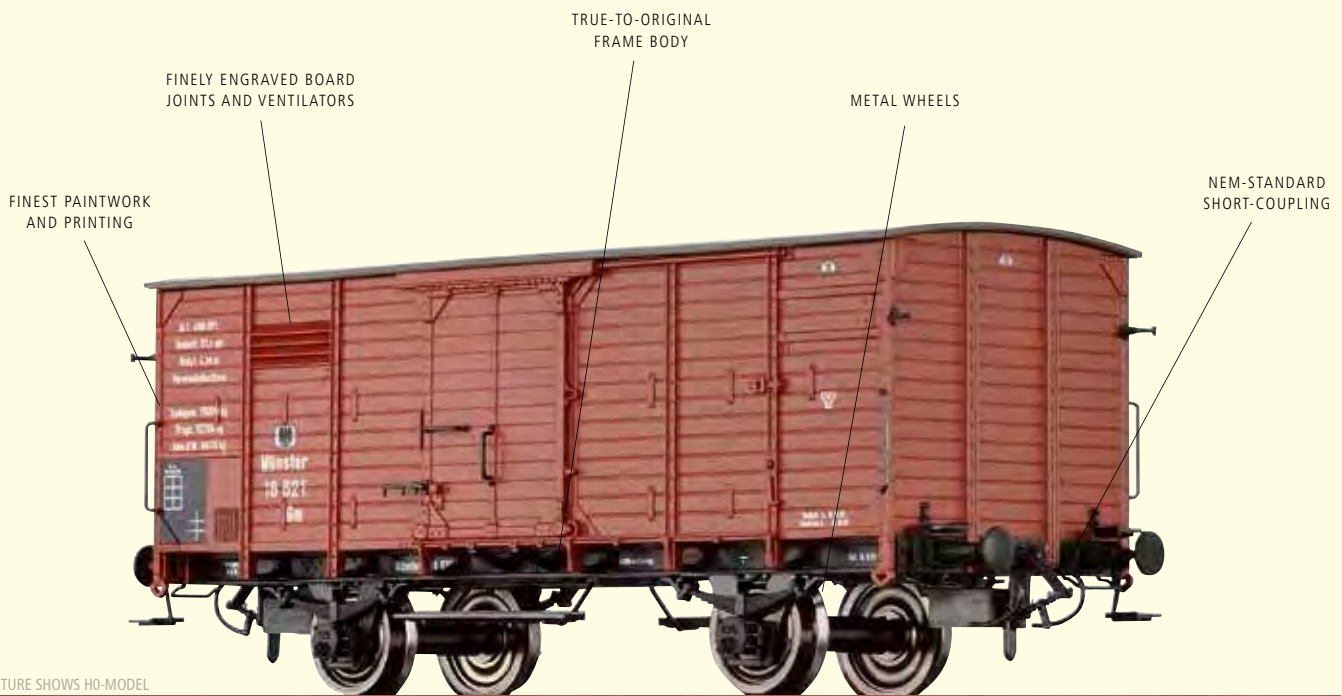

Covered Freight Car Gm K.P.E.V.
Road no. Münster 18 621



PICTURE SHOWS HO-MODEL

Order no. **67440**    

DELIVERY DATE: 4TH QUARTER 2017

Covered Freight Car Gn DRG
Road no. Cassel 78 455



PICTURE SHOWS HO-MODEL

Order no. **67441**    

DELIVERY DATE: 4TH QUARTER 2017

Covered Freight Car G10 DB
Road no. 141 366



PICTURE SHOWS HO-MODEL

Order no. **67442**    

DELIVERY DATE: 4TH QUARTER 2017

Covered Freight Car Gklm 191 DB
Road no. 20 80 112 4 901-7



PICTURE SHOWS HO-MODEL

Order no. **67443**    

DELIVERY DATE: 4TH QUARTER 2017

Covered Freight Car G DR
Road no. 21 50 112 7020-8



PICTURE SHOWS HO-MODEL

Order no. **67444**    

DELIVERY DATE: 4TH QUARTER 2017



Covered Freight Car G DR
Road no. 05-42-46



Order no. **67434** 54,9

AVAILABLE

Covered Freight Car G "DARMOL" DRG
Road no. Stuttgart 513 123 [P]



Order no. **67418** 54,9

AVAILABLE

Covered Freight Car G10 "Südzucker" DB
Road no. 123 672



Order no. **67420** 54,9

AVAILABLE

Covered Freight Car G10 "Pattex" DB
Road no. 132 485



Order no. **67423** 54,9

DELIVERY DATE: 4TH QUARTER 2017

Covered Freight Car G10 "Felix" DB
Road no. 136 351



Order no. **67448** 54,9

DELIVERY DATE: 4TH QUARTER 2017

Covered Freight Car G "Anker Brot" ÖBB
Road no. 161 643



Order no. **67422** 54,9

AVAILABLE



Covered Freight Car Lw SNCF / EUROP
Road no. 7494223



Order no. **67427**  58,1    

AVAILABLE

Covered Freight Car Qc GDS
Road no. 122





Order no. **67428**  58,1   **GDS**

AVAILABLE

Covered Freight Car Z CSD
Road no. 1.47307



Order no. **67439**  54,9   **ČSD**

DELIVERY DATE: 2ND QUARTER 2017



360°

Finest details from every angle
Discover all 360°-views from BRAVA



Tank Car Z [P] "Albizol/Monopolin" DRG
Road no. Berlin 591 326 [P]



Order no. **67527**  54,9   

DELIVERY DATE: 3RD QUARTER 2017

Tank Car Z [P] „IVG“ DB
Road no. 5 527 115 [P]



Order no. **67517**  54,9   

DELIVERY DATE: 3RD QUARTER 2017

Tank Car Z [P] "Optimol" DB
Road no. 516 627 P



Order no. **67524**  54,9   

DELIVERY DATE: 3RD QUARTER 2017

Tank Car Z [P] "Alles klar mit Korn" DB
Road no. 21 80 735 5 842-9 P



Order no. **67525**  IV  54,9   

DELIVERY DATE: 3RD QUARTER 2017



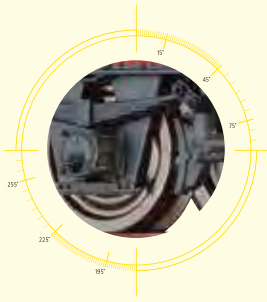

1_Brake shoes in wheel plane

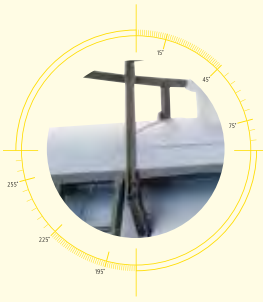

2_Extra walkway on the boiler

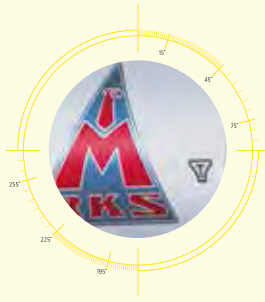

3_Finest paintwork and printing

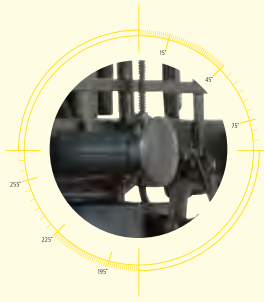





4_Separately mounted buffers



5_Originally reproduced,
three-dimensional frame body

Tank Car Z [P] "VTG" DB
Road no. 23 80 735 0 189-5 [P]







Order no. **67518**  54,9   

DELIVERY DATE: 3RD QUARTER 2017

Tank Car SCwf "Ugilor" SNCF
Road no. 571 865 [P]







Order no. **67523**  54,9   

DELIVERY DATE: 3RD QUARTER 2017

Tank Car Z [P] "Zoutindustrie" NS
Road no. 530 712 [P]







Order no. **67516**  54,9   

DELIVERY DATE: 3RD QUARTER 2017

Tank Car Z [P] "Nieuwe Matex" NS
Road no. 510 129 [P]







Order no. **67522**  54,9   

DELIVERY DATE: 3RD QUARTER 2017

Tank Car Z [P] "Stroh & Co." ÖBB
Road no. 21 81 001 1 427-9 [P]







Order no. **67521**  54,9   

DELIVERY DATE: 3RD QUARTER 2017

Tank Car ZE "J.A.F." DSB
Road no. 503 295 [P]



Order no. **67526**  54,9   

DELIVERY DATE: 3RD QUARTER 2017

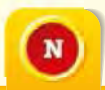



ALWAYS ONE STOP AHEAD

BRAWA OFFERS WORKSHOP VIDEOS VIA
AN OWN CHANNEL ON YOUTUBE

A new service from BRAWA is our own YouTube channel. In our workshop videos, we present new models and functions – for instance the diesel locomotive V 100 in H0 gauge with driven fan and electronic coupling. As an example, the TRAXX diesel locomotive video shows you the excellent slow driving properties of the H0 model and presents product details such as the interference-free 16-bit sound or the extensive lighting functions. It's worth taking a look, because we constantly update our BRAWA YouTube channel. Even before new models are delivered to specialist dealers, you can get an initial impression of the numerous details that distinguish our products here.



Simply scan the QR code to access the BRAWA YouTube channel on your tablet or smartphone.

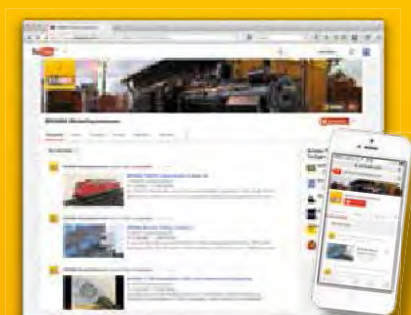

BRAWA YOUTUBE - CHANNEL



BRAWA ALSO SHOWS OFF THE BEST SIDE OF ITS MODELS ONLINE

FINEST DETAILS FROM EVERY ANGLE

It goes without saying that you can experience our attention to detail online, 24 hours a day. For this purpose, we have integrated the 360 degree view on our website for instance: You can rotate numerous locomotives and wagons around their own axes at the click of a mouse button. In doing so, you can individually control how quickly the model rotates by using the slide control, thus being able to have a good look at all details at your leisure. But that's not all that awaits you at www.brawa.de. Simply come back from time to time, we'll keep you up to date!



Simply scan the QR code to access the BRAWA 360 degree views.



WWW.BRAWA.DE



CUTS WAITING TIME. THE BRAWA NEWS EXPRESS

SUPPLEMENTARY PUBLICATIONS

In order to inform you even faster on novelties and to shorten the waiting time, The News Express will be published up to three times a year in the future. It will also introduce models that you won't find in the new items brochure and these models will be available at short notice. So look forward to The News Express! It will be available at trade fairs and in specialised trade shops, and will be sent out by mail or e-mail.

The first issue appears already in the spring 2017 - you may be curious!



BRAWA NEUHEITEN EXPRESS



AUTOMATICALLY RECEIVE NEWS FROM BRAWA

ALWAYS UP-TO-DATE

Which new models are in the starting blocks?

Are technical innovations in the pipeline? Where can I experience BRAWA live in the near future?

The fastest way to receive information is to subscribe to our free BRAWA e-newsletter. It provides regular reports of the current happenings at BRAWA - from new products to current events and interesting workshops reports. With the e-newsletter, you'll become a BRAWA insider as, here, you will receive the latest news prior to publication on our website.



BRAWA E-NEWSLETTER









EXCLUSIVE LIMITED EDITION MODELS 2017

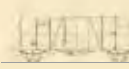
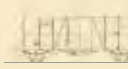
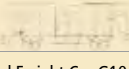
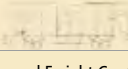

SECURE YOUR PERSONAL MODELS AS QUICKLY AS POSSIBLE!

To coincide with its anniversary year, BRAWA is releasing a total of 7 exclusive series models in the H0 and N gauges at the Nuremberg Toy Fair, all in strictly limited editions. The wagons with advertising panels can be exclusively ordered from BRAWA specialist dealers during the 2017 Toy Fair.

So contact your BRAWA specialist dealer as quickly as possible to secure your own model now.

"Technical History", set of 10*				
 Covered Freight Car Gms 30 „Krauss Maffei“ DB, Ep. III Order no. 47967	 Covered Freight Car Gms 30 „Borsig“ DRG, Ep. II Order no. 47968	 Covered Freight Car Gms 30 „Henschel“ DB, Ep. III Order no. 47969	 Covered Freight Car Gms 30 „O&K“ DB, Ep. III Order no. 47970	 Covered Freight Car Gms 30 „MaK“ DB, Ep. III Order no. 47971
 Covered Freight Car G10 „Säch- sische Maschinenfabrik Hartmann“ K.S.St.E.B., Ep. I Order no. 49706	 Covered Freight Car G10 „Maschinenfabrik Esslingen“ K.W.St.E., Ep. I Order no. 49707	 Covered Freight Car G10 „Ho- henzollern“ DRG, Ep. II Order no. 49708	 Covered Freight Car G10 „BMAG“ DRG, Ep. II Order no. 49709	 Covered Freight Car G10 „Krupp“ DB, Ep. III Order no. 49710

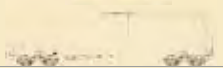
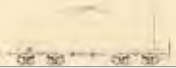
DELIVERY DATE: 4TH QUARTER 2017

"Tank Cars", set of 4*			
 Tank Car ZZ [P] „BASF“ DB, Ep. III Order no. 47400	 Tank Car Zas GATX, Ep. V Order no. 48765	 Tank Car ZZ [P] „DEA“ DB, Ep. IV Order no. 48931	 Tank Car Z [P] „EVA“ DB, Ep. IV Order no. 49230

"Economic Miracle", set of 4*			
 Covered Freight Car Gms 30 „Osram“ DB, Ep. III Order no. 47963	 Covered Freight Car Gms 30 „Erdal“ DB, Ep. III Order no. 47964	 Covered Freight Car Glr 23 „Magirus Deutz“ DB, Ep. III Order no. 48715	 Covered Freight Car G10 „Vivil“ DB, Ep. III Order no. 49096

"Chocolates", set of 4*

HO

 <p>Covered Freight Car Bay. Milchwagen „Rittersport“ DB, Ep. III Order no. 48657</p>	 <p>Covered Freight Car Bay. Milchwagen „Sarotti“ DRG, Ep. II Order no. 48658</p>	 <p>Covered Freight Car Bay. Milchwagen „Eszet“ DB, Ep. III Order no. 48659</p>	 <p>Covered Freight Car Bay. Milchwagen „Stollwerck“ DRG, Ep. II Order no. 48660</p>
---	---	---	--





"Brands of the GDR", set of 4*

HO

 <p>Covered Freight Car Hkms „Fewa“ DR, Ep. IV Order no. 47965</p>	 <p>Covered Freight Car Gags-v „IFA“ DR, Ep. IV Order no. 48390</p>	 <p>Tank Car Uia „Bautzener Senf“ DR, Ep. IV Order no. 48767</p>	 <p>Covered Freight Car G10 „Kathi“ DR, Ep. III Order no. 49702</p>
--	---	---	---

"Tank Cars", set of 4*

N

 <p>Tank Car ZZ [P] „BASF“ DB, Ep. III Order no. 67071</p>	 <p>Tank Car Zas GATX, Ep. V Order no. 67248</p>	 <p>Tank Car ZZ [P] „DEA“ DB, Ep. IV Order no. 67710</p>	 <p>Tank Car Z [P] „EVA“ der DB, Ep. IV Order no. 67520</p>
--	--	---	---

"Economic Miracle", set of 4*

N

 <p>Covered Freight Car Gms 35 „Osram“ DB, Ep. III Order no. 67314</p>	 <p>Covered Freight Car Gms 35 „Erdal“ DB, Ep. III Order no. 67315</p>	 <p>Covered Freight Car G10 „Magirus Deutz“ DB, Ep. III Order no. 67446</p>	 <p>Covered Freight Car G10 „Vivil“ DB, Ep. III Order no. 67447</p>
--	--	---	---

* For specialist dealers only available as set.
Delivery dates: see BRAWA-Website



OUR ATTENTION TO DETAIL IS ALSO VALID IN SERVICE

Your concern is always important to us. This is why our hotline is available to you at any time during our business hours.

Your concern will be taken care of personally, flexibly, and proficiently. You can also find the right answer to many frequently asked questions on our website on a 24/7 basis.

www.brawa.de/faq

QUESTIONS RELATING TO DIGITAL TECHNOLOGY

Is it possible to digitise BRAWA locomotives at a later date?

All H0 locomotives, except the BRAWA basic variants, have standardised interfaces. They can therefore be upgraded easily using a commercially available decoder.

Which digital systems are supported by the BRAWA decoder?

We support DCC, Motorola, and Selectrix.*

Which decoders are used by BRAWA for locomotives?

We use decoders from Doehler & Haass that are tuned to our models in each case. With their Super-Soft-Drive engine control systems, they ensure perfect running characteristics. These electronic components which are completely developed and produced in Germany are now available from specialist BRAWA retailers.

QUESTIONS RELATING TO THE SERVICE

Can I send my locomotive to BRAWA for repair?

You are welcome to send your model directly to BRAWA for repair.

We carry out all repairs in-house – with love, know-how, and speedily – so that you get back your precious piece very soon.

How can I get an instruction manual?

The instruction manuals for our models are enclosed with the respective product packing. If you have misplaced or lost your instruction manual you can find a corresponding PDF document for any model on our website. For this purpose, please visit the respective product page.

You may also search directly for the appropriate PDF file by entering the item number under Download/Manuals.

How can I get genuine BRAWA spare parts?

You may order spare parts via your specialist dealer or make your enquiry directly with BRAWA. A detailed spare parts sheet is enclosed with each packing. This sheet can be used to order the desired spare parts. Please note that only the items listed are available as spare parts. If spare parts are ordered via BRAWA we will deliver free domicile within Germany. Please note that we will charge a flat-rate processing fee of EUR 5.00.

WWW.BRAWA.DE/FAQ





EXPERIENCE BRAWA LIVE TRADE FAIRS AND EVENTS

Experience new products, classic models and the people behind them live at trade fairs and events. Visit us at several model-making and model railway fairs in Germany. Additionally our specialized dealers in Germany invite you to the BRAWA expert days.

Check our website for dates and addresses.

www.brawa.de/en/fairs



THE SYMBOLS AND THEIR MEANING

Era designation	Navigable minimum radius in mm	Locomotive has flywheel drive	The model has spring buffers
Direct current Analog	Can be switched over to overhead line operation	Double headlights alternating with the direction of travel	Replacement wheel set for AC (e. g. BRAWA product code 2180)
Direct current Analog BASIC	NEM 651 interface	Double headlights and one red taillight alternating with the direction of travel	AC pick-up can be retrofitted (e. g. BRAWA product code 2220)
Alternating current Analog BASIC+	NEM 652 interface	Triple headlights alternating with the direction of travel	Integrated sound
Alternating current Digital	Interface with soldering points	Triple headlights and two red taillights alternating with the direction of travel	Prepared for sound
Alternating current Digital EXTRA	Next 18 interface	Two red taillights	Vehicle predominantly in metal
Direct current Digital	21-pole interface	With interior lighting	Logo of the railway company (e. g. DRG)
Direct current Digital BASIC+	PluX22 interface	Interior lighting can be retrofitted (e. g. BRAWA product code 2200)	Digital Coupling
Direct current Digital EXTRA	Number of wheels with friction tyres	With interior fittings	Functional, switchable fan
Decoder Doehler & Haass	Locomotive has a smoke generator	The model has a coupler pocket but no short coupling cinematic	Energy Storage
Length over buffer in mm	Locomotive is prepared for the installation of a smoke generator (e. g. Seuthe No. 20)	The model has a coupler pocket and short coupling cinematic	

Products modifications are possible after this brochure is printed. Subject to modifications in design and shape. Colour deviations are possible.

ALAK, Albizol, Alles klar mit Korn, Amstel Brouwerij, Anker Brot, Antuka, Badoit, Bähre Mignon Möbel, Bahlsen, BASF, Bautzener Senf, Berentzen Traditionskorn, BLS, BMAG, Bombardier Transportation, Borsig, Boterverkoop, BP, Buna, Car-goNet, Cosmanos, Crossrail, CSD, Darmol, DB AG, DB Cargo AG, DB Regio, DEA, Doehler & Haass, Doornkaat, Dortmund Stiffts-Bier, DSB, Dynamit Nobel, Erdal, Erstes Kulmbacher Actienbier, ESSO, Eszet, EVA, Fazeni, Felix, FEWA, Fritz Homann, FS, Gasolin, GATX, Goggio Motorroller, Gösser Bier, Grand Danois, Green Cargo, Hansaplast, Henschel, H. F. Wiebe, Hohenzollern, IFA, Interfrigo, IVG, J. A. F., Kaiser Bier, Kaldewei Badewannen, Kathi, Knorr, Krauss Maffei, Krupp, Lambiotte, Lenz, Leuna, Libella, Locataire Naphthachemie, Märklin, Maggi, Magirus Deutz, Main-Spessart-Express, MaK, MAN, Maschinenfabrik Esslingen, Metrans, Monopolin, Nieuwe Matex, Nivea, NS, ÖBB, OMV, Optimol, Osram, Ovomaltine, O & K, Pattex, Peugeot Talbot, PEZ, Prior, Ritter Sport, Sächsische Maschinenfabrik Hartmann, Salzburger Lokalbahn, Sarotti, SBB, Sersa, Simontra, SNCB, SNCF, Staatsmijnen, STEF, Stollwerck, Stroh & Co., Südzucker, TEXACO, TRAXX, TWINDEXX Vario, Uglor, Ülße, VEB Bitterfeld, Vivil, VTG, Wismut AG, Zoutindustrie and Zwanenberg are registered trademarks.

LIEBE ZUM DETAIL



MILESTONE IN ELECTRIC LOCOMOTIVE:
THE ELECTRIC LOCOMOTIVE E 44 DB FROM BRAWA

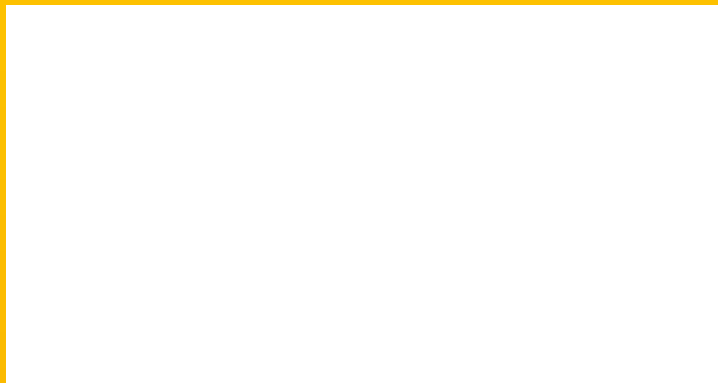

BRAWA Artur Braun Modellspielwarenfabrik GmbH & Co. KG Uferstr. 26-30 73630 Remshalden
Hotline: Monday – Thursday: 1 p.m. to 3 p.m. Phone +49 7151 97935-68
Fax +49 7151 74662 info@brawa.de www.brawa.de

BRAWA
A PASSION FOR DETAIL